

SPRINGFREE™ TRAMPOLINE
WITH FLEXINET™ SAFETY ENCLOSURE
MODEL SF90E



Trampoline and Enclosure Assembly, Installation,
Care, Maintenance and Use Instructions

Version 6.2



WARNING: Read these materials prior to assembling and using this trampoline and enclosure. In our commitment to customer satisfaction and safety, please check our website regularly for important customer updates.



WARNING: Read these materials prior to assembling and using this trampoline and enclosure



Do not attempt or allow somersaults. Landing on the head or neck can cause serious injury, paralysis or death even when landing on the middle of the bed.



Do not allow more than one person at the same time on the trampoline or enclosure. Use by more than one person can result in serious injury.



Keep face clear of loaded trampoline and enclosure rods, particularly during assembly and disassembly.



Do not attempt to disassemble trampoline enclosure support rods from the rod joiner mechanism while the rods are installed in the trampoline and under tension.

Recommended weight limit: 220 lbs (100 kg)

(Please refer to the Safe Use Bulletin for a detailed description about weight limits).

The Springfree™ Model SF90E trampoline has been designed for optimal use by most healthy children and adults. Persons at or near this weight should be cautious in their maneuvers to ensure they do not initiate contact with the ground via the mat which may cause injury. The SF90E has been static load tested to 1100 lbs (500 kg) using methodology described in standard BS EN 13219-2001.

Stability recommendation

The FlexiNet™ safety enclosure system catches and cushions users from impact that may result from leaving the jumping surface. Vigorous, high-speed contact with the FlexiNet™ safety enclosure by persons approaching the recommended weight limit may result in tilting or tipping of the trampoline off its base.

For increased stability during use, especially for users approaching the 220 lb (100 kg) weight limit, we recommend that you use the supplied sandbags (described in the assembly instructions). The sandbags also help keep the trampoline down in windy weather.

WARNINGS

1. DO NOT attempt or allow somersaults. Landing on the head or neck can cause serious injury, paralysis, or death, even when landing in the middle of the bed.
2. DO NOT allow more than one person on the trampoline/inside the enclosure. Multiple jumpers increase the chances of loss of control and this can result in broken head, neck, back, or leg, or other serious injury.
3. Use trampoline/enclosure only with mature, knowledgeable supervision. Enforce all safety rules and be familiar with the information in the User's Manual to assist in following trampoline enclosure instructions and trampoline safety.
4. Do not exceed the weight limit recommended by the manufacturer.
5. Trampolines over 20 in. (51 cm) tall, and enclosures, are not recommended for use by children under 6 years of age.
6. Inspect the trampoline/enclosure before each use. Make sure the barrier and the enclosure support system (rods) are correctly and securely positioned. Replace any worn, defective, or missing parts.
7. Use only when the enclosure barrier has no holes, pole clamps are tightly secured to the poles (where applicable) and the support (frame), and the barrier is properly suspended.
8. Climb on and off the trampoline at the enclosure door. It is a dangerous practice to jump from the trampoline to the floor or ground when dismounting, or to jump onto the trampoline when mounting. Do not use the trampoline as a springboard to other objects.
9. Bounce in the centre of the mat.
10. Stop bounce by flexing knees as feet come in contact with the trampoline bed. Learn this skill before attempting others.
11. Learn Fundamental bounces and body positions thoroughly before trying more advanced skills. A variety of trampoline activities can be carried out by performing the basic fundamentals in various series and combinations, performing one fundamental after another, with or without feet bounces in between them.
12. Avoid bouncing too high or for too long. Stay low until bounce control and repeated landing in the centre of the trampoline can be accomplished. Always control your bounce. Control is more important than height. Do not try to jump over the enclosure.
13. While keeping the head erect, focus eyes on the trampoline toward the perimeter. This will help control your bounce.
14. Avoid bouncing when tired. Keep turns short.
15. Bounce only when the surface of the bed is clean and dry. Wind or air movement should be calm to gentle. The trampoline must not be used in gusty or severe winds.
16. Do not allow a child or other persons under the trampoline.
17. Keep small children away from the trampoline while others are bouncing on it, because the edge can move in and out vigorously, and there is potential for a rod to pop out if the bouncer lands heavily near the edge.
18. Do not use the trampoline/enclosure while under the influence of alcohol or drugs.
19. Keep objects that could interfere with the performer out of the way. Maintain a clear area around the trampoline.
20. Properly secure the trampoline/enclosure when not in use. Protect it against unauthorized use. If a trampoline ladder is used, the supervisor should remove it from the trampoline when leaving the area to prevent unsupervised access by children under 6 years of age.
21. Use only when the enclosure barrier has no holes, rods are secure in the sockets, the sockets are tightly secured to the trampoline frame, and the enclosure is properly suspended.
22. Do not intentionally rebound off the enclosure. Do not hang, kick, cut or climb on the enclosure. Do not attempt to jump over or climb under the enclosure.
23. Wear clothing free of drawstrings, hooks, loops, or anything that could get caught in the enclosure.
24. Do not attach anything to the enclosure that is not a manufacturer-approved accessory or part of the enclosure system.

25. Do not jump from other objects, buildings, or surfaces, onto the trampoline, or into or over the trampoline enclosure.
26. For information concerning skill training, contact a certified trampoline instructor.
27. Read all instructions before using the trampoline/enclosure. Warnings and instructions for the care, maintenance and use of this trampoline are included to promote safe, enjoyable use of this equipment.
28. The Springfree™ Trampoline has the industry's highest weight to area ratio. However, in extreme wind conditions the large surface area of the mat can capture enough wind energy to result in the trampoline being lifted from its installation location. Owners of trampolines installed in areas susceptible to high winds, or owners who wish to anchor their trampoline as a result of this warning should consider applying some type of anchoring system to the base of the trampoline legs.
29. In our commitment to customer satisfaction and safety, please check our website regularly for important customer updates.
30. For additional information concerning the trampoline equipment, please contact the manufacturer or regularly check our website for important customer updates.

The Springfree™ Trampoline and FlexiNet™ safety enclosure design is protected by a number of international patents (granted and pending) and registered designs. At the time of printing of this manual, these include: US patent 6319174; New Zealand patent 513331; China Patent ZL02825390.6; European registered design 000126602-0001; Australian registered design 311568-75; Other international patents pending. Please check <http://www.uspto.gov> for latest updates. Springfree™ Trampoline is a registered trademark of Board & Batten International Inc. FlexiNet™ is a registered trademark of Board & Batten International Inc.

CONTENTS

7	Before you get started
9	Trampoline and Enclosure Assembly Instructions
19	Trampoline And Enclosure Disassembly Instructions
21	Basic Trampoline Skills
27	Warranty
28	Springfree™ Worldwide Authorized Service Contacts
29	Springfree™ Trampoline Materials Authorization Form



AUSTRALIA

Springfree Trampoline Aust Pty. Ltd.
60 Hoopers Road
Kunda Park
Queensland, 4556
Australia

free: 1800 JUMP SAFE
1800 123 204
fax: 07-5451 0170
email: fun@springfreetrampoline.com.au
web: www.springfreetrampoline.com.au

NORTH AMERICA

Springfree Trampoline Inc.
7100 Warden Avenue, Unit 3
Markham, ON L3R 8B5
Canada

free: 1-800-899-7370
fax: 1-905-948-0016
email: sales@springfreetrampoline.com
web: www.springfreetrampoline.com

BEFORE YOU GET STARTED

Thank you very much for purchasing the Springfree™ Trampoline.

Before you assemble and enjoy the trampoline, please ensure that you read and fully understand the Warnings, Installation and Placement Instructions, Care and Maintenance Instructions, User and Owner Responsibilities and Assembly Instructions. In our commitment to customer satisfaction and safety, please check our website regularly for important customer updates.

Trampoline and Enclosure Installation and Placement Instructions

1. Adequate overhead clearance is essential. A minimum of 24 ft (7.32 m) from ground level is recommended. Provide clearance for wires, tree limbs, and other possible hazards.
2. Lateral clearance is essential. Place the trampoline/enclosure away from walls, structures, fences, and other play areas. Maintain a clear space on all sides of the trampoline/enclosure.
3. Place the trampoline/enclosure on a level surface before use.
4. Use the trampoline/enclosure in a well-lit area. Artificial illumination may be required for indoor or shady areas.
5. Secure the trampoline/enclosure against unauthorized and unsupervised use.
6. Remove any obstructions from beneath the trampoline/enclosure.
7. Do not attempt to use the trampoline/enclosure until it is completely assembled.
8. The owner and supervisors of the trampoline/enclosure are responsible to make all users aware of practices specified in the use instructions.
9. The trampoline enclosure is only to be used as an enclosure for a trampoline and the trampoline must be of the appropriate size as covered by the specific enclosure.

Care and Maintenance Instructions

Inspect the trampoline/enclosure before each use and replace any worn, defective, or missing parts. The following conditions could represent potential hazards:

1. Punctures, frays, tears, or holes worn in the bed, mat edge system, or net.
2. Deterioration in the stitching or fabric of the bed, mat edge system, or net.
3. Broken, missing, or splintered trampoline rods, or rods disconnected from the mat edge.
4. A bent or broken frame, or sharp protrusions on the frame.
5. A sagging bed, or a loose enclosure net; improperly or insecurely attached bed or enclosure net.
6. Rods not fully inserted into sockets or ball joint not fully engaged mat edge.
7. Deteriorated, missing or damaged plastic edge fittings (If the plastic edge fittings have deteriorated or are damaged, rods may release and cause injury. Inspect regularly, but keep face well clear in the process. Check that the ball retainer clip is engaged. Replace damaged components).
8. Enclosure support rods and attachment fittings missing, broken or improperly assembled.
9. Enclosure rods not fully up into the net pockets.
10. Missing C-clips from the sockets on the frame.

The soft edge of the Springfree™ trampoline is designed to reduce injury. It is not designed to cope with deliberate, continuous, vigorous bouncing activity. Do not deliberately bounce around the edge.

Winter Care Instructions

Customers who live in colder climates frequently ask us how to care for their trampoline in the winter. There are in fact no special winter care instructions other than to clear the snow off your trampoline after heavy snow accumulation.

Do not use a shovel to remove the snow off your trampoline, because it may damage the mat or enclosure net.

Springfree™ Trampoline is constructed with all-weather parts including rust-free fiberglass rods and UV-resistant polypropylene mat and safety enclosure. Regardless of your climate, you can enjoy your Springfree™ Trampoline all year round.

Responsibilities for Trampoline Safety and Accident Prevention

RESPONSIBILITIES OF THE OWNER AND SUPERVISOR

1. Provide supervision for all jumpers regardless of age or skill.
2. Understand all of the safety rules and information in the User's Manual and ensure the rules are being followed.
3. Assess skill levels, provide basic jump instructions, and ensure all users understand and follow the trampoline safety guidelines.
4. Ensure that unsupervised or unauthorized users are not permitted to jump.
5. Keep small children away from the trampoline while others are bouncing on it.
6. Do not allow a child or other persons under the trampoline.
7. Ensure there is only one jumper on the trampoline at a time

RESPONSIBILITIES OF THE USER

1. Climb on and off the trampoline. Do not jump on or off the trampoline.
2. When initially using the trampoline, begin in the centre of the mat with low controlled bounces.
3. Before jumping warm up the muscles, which also increases blood flow, which increases flexibility, joint mobility and reduces the risk of injury.
4. Understand basic techniques such as stop bounce and basic straight jump.
5. Understand and follow all the safety guidelines. In particular avoid doing flips and jump with only one person on the trampoline at a time.
6. Make sure someone is supervising at all times.

For further information or additional instructional materials, contact a certified trampoline instructor.

TRAMPOLINE AND ENCLOSURE ASSEMBLY INSTRUCTIONS

Read through the following steps before beginning the assembly process.

Precautions

- Keep small children at least 25 feet away while assembling or disassembling the trampoline; they could be injured by improperly assembled rods releasing and ejecting from the frame.
- Do not attempt to use the trampoline until it is completely assembled.
- Two people are recommended for trampoline assembly.
- Gloves are recommended during the assembly process.
- Be aware that when loaded, the rods can

spring back and may cause injury.

- Treat any loaded rod with caution until you are sure it is properly installed. In particular, keep your face well clear of the rods during assembly or disassembly. An improperly installed rod could release and cause facial injury or blindness.
- The sheath on the rod is intended to provide protection from any fiberglass fibres or splinters. Do not remove the sheath.
- Once a rod ball is in the socket in the mat, a small clip automatically engages to lock it in place. To release a rod ball from a socket, push and hold the clip towards the mat centre before pushing the rod out of the socket.

TRAMPOLINE		ENCLOSURE	
Frame Sections	6	Net	1
Legs	6	Collapsible Rods	12
Vertical Leg Supports	6	C-clips (attached to frame)	12
Rods	90		
Mat	1	SPARES	
Bolts and Nuts	12	1 Spare Bolt/Nut	
Wrench	2	3 C Clips	
Sandbags	6		

Preparation

Confirm all components are present (Table 1). If you are missing any parts please call your authorized Springfree™ service centre listed in the end section of this manual.

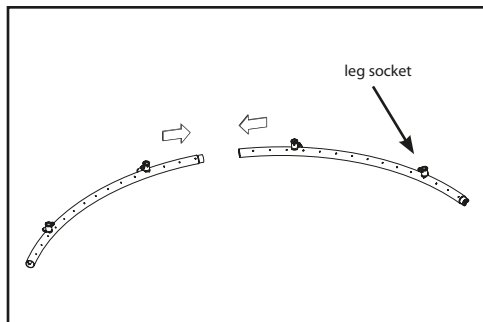

Figure 1: Assembling frame sections

Step 1: Assembling the frame sections

Assemble one pair of frame sections, with the leg sockets facing upwards.

Table 1: Parts itinerary

Step 2: Attaching legs to frame sections

Locate the joint between two connected frame sections.

Attach a vertical leg support to a leg piece (Figure 2-A). Next, insert the leg with the support into the sockets on the frame.

Note that the vertical leg support is off to one side. Make sure the saddle of the vertical leg support meets at the joint in the frame. This will ensure the middle support leg saddle is positioned correctly. If it does not, remove the leg and turn it around (Figure 2-B).

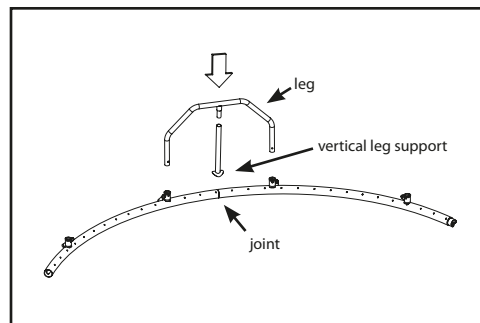

Figure 2-A: Inserting a leg piece and vertical support

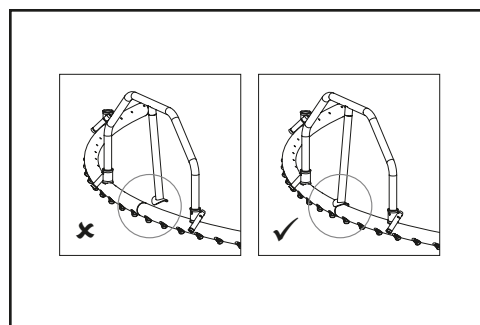

Figure 2-B: The wrong orientation (left) and the right orientation (right) for the vertical leg support

Step 3: Fastening the legs to the frame

Fasten the legs to the frame with the bolts and nuts provided. Do not over-tighten.

If the holes do not line up, check that the leg is the right way round (refer to Figure 2-B) or lift the leg slightly.

The nut should be towards the mat centre; the bolt head should be towards the outside.

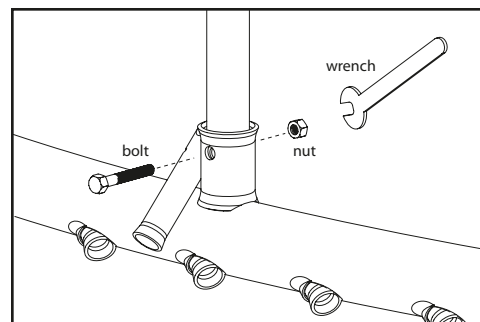

Figure 3: Fastening the legs to the frame

Step 4: Connecting frame pairs

Repeat Step 1 through Step 3 for the remaining frame sections.

Turn the 3 groups over, and then connect them together to complete the frame.

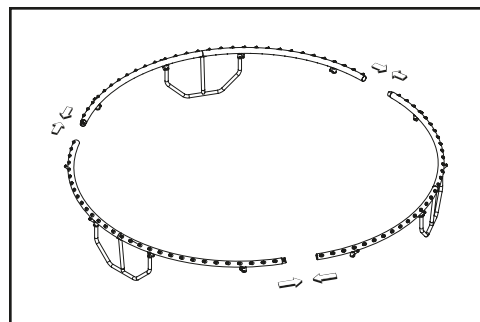

Figure 4: Connecting the frame sections

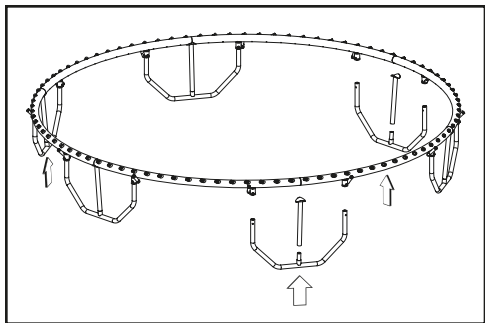

Figure 5: Attaching the final legs and vertical supports

Step 5: Attaching the final legs

Install a leg unit with vertical support into each of the 3 remaining socket pairs.

As before make sure the saddle of each vertical leg support meets at the joint in the frame. If not, remove the leg and turn it around.

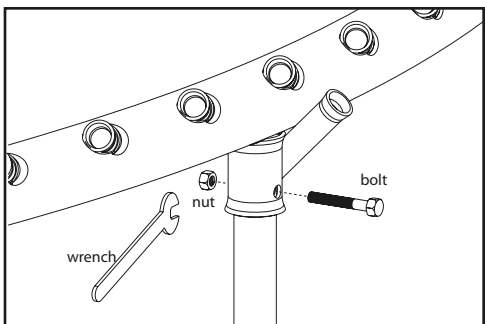

Figure 6: Fastening the last two legs

Step 6: Fastening the final legs

Fasten the remaining legs to the frame with the bolts and nuts provided. (Do not over-tighten.) Check that there is a bolt properly installed in each of the 12 leg uprights.

Again, the nut should be towards the mat centre; the bolt head should be towards the outside.

It is essential for the stability of the frame that there is a bolt in each leg upright.

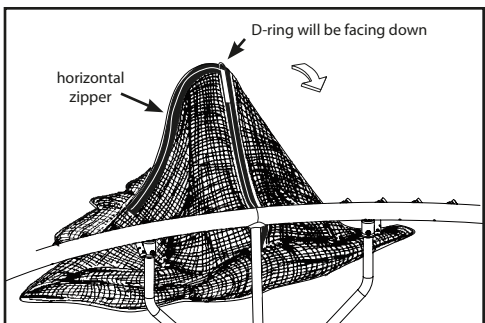

Figure 7-A: Positioning the enclosure net (as viewed from within trampoline frame)

Step 7: Positioning the enclosure net

Place the enclosure net at the base of one of the legs. Locate the zippers (the door) of the enclosure; at the intersection of the vertical and horizontal zippers there is a steel D-ring. Adjust the net so the D-ring side faces ground and the horizontal zipper runs parallel to the frame from left to right (Figures 7-A and 7-B).

Tip: Tip: Follow the next 3 steps carefully to place the enclosure net properly. Not following these steps carefully may result in the enclosure being installed inside out.

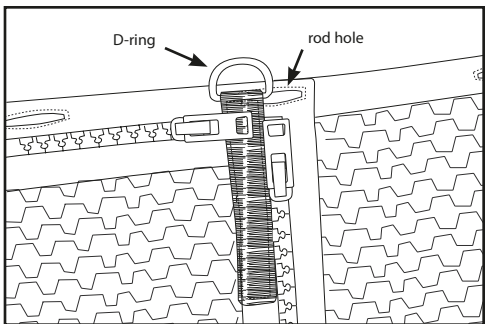

Figure 7-B: The D-ring at the horizontal and vertical zipper intersection

Step 8: Inserting the first rod

Find the net anchor strip with the holes in it (along the base of the net). Insert a rod through the hole where the vertical zipper comes to a close.

Now, insert this rod into the fifth socket to the right of the frame joint. If the rod is in the correct (fifth) socket, its ball will be above this frame joint when viewed straight on.

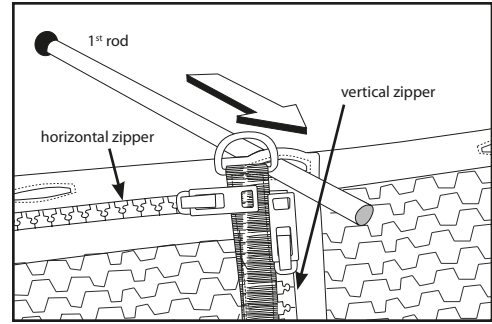

Figure 8-A: Placing the first rod

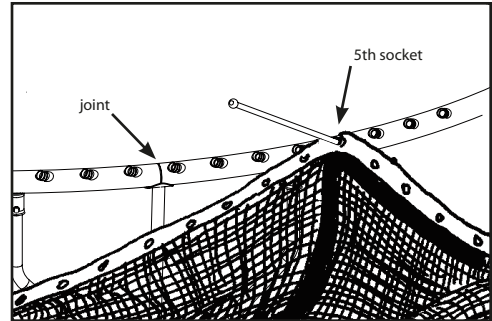

Figure 8-B: The first rod through the net and in its socket

Step 9: Laying the enclosure net

At this point, lay the enclosure net around the outside of the frame of the trampoline (Figure 9).

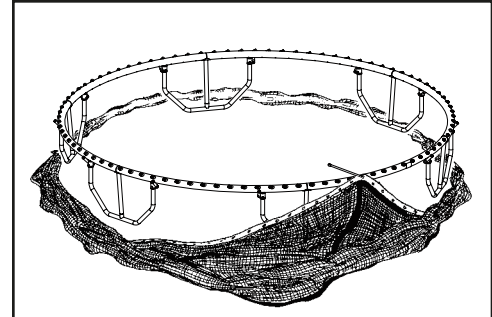

Figure 9: The net laid around the frame

WARNING: Ensure the rods are seated right down to the bottom of each socket. Rods that are improperly seated may eject unexpectedly, which may cause injury.

Step 10: Inserting the other rods

Insert the remaining rods through each hole in the bottom strip of the enclosure and into the respective sockets.

Ensure the rods are seated right down to the bottom of each socket.

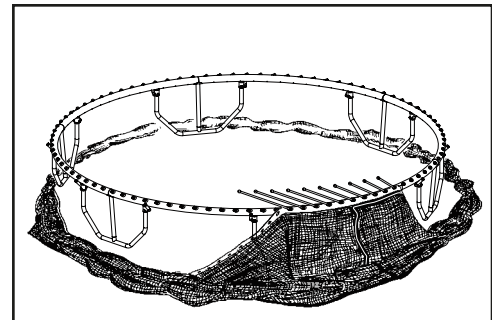

Figure 10: Inserting the remaining rods

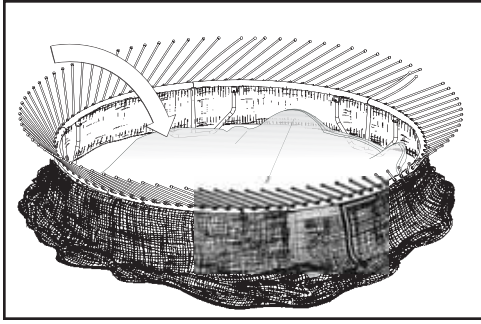

Figure 11: Placing the mat inside the frame

Step 11: Laying down the mat

When all rods are in place, put the mat inside the frame with the jumping surface facing up. The jumping surface has the colored (usually yellow) stripes sewn around the edge.

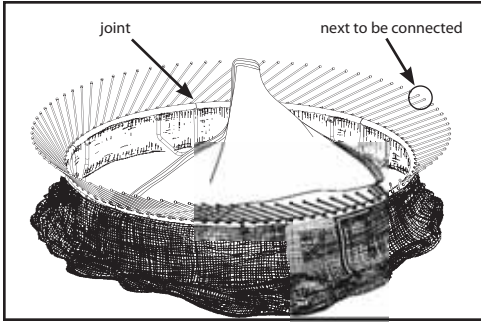

Figure 12-A: Attaching the mat to the rods

Step 12: Attaching the first rods to the mat

Choose the rods on either side of a joint in the frame. Connect the ball ends of these two rods to two adjacent fittings in the mat.

WARNING: Treat any loaded rod with caution until you are sure it is properly installed or uninstalled. Keep your face well clear of any loaded rod.

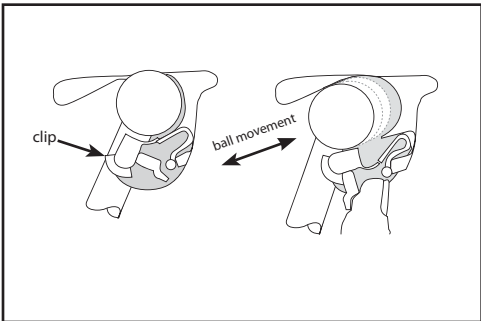

Figure 12-B: Safety clip operation. Clip secured (left); Clip released (right)

Tip: Make sure the safety clip in the mat-edge socket has closed behind the ball. If the ball is properly installed, you should not be able to slide the ball out of the mat socket (Figure 12-B).

Step 13: Attaching the next 2 rods to the mat

Moving from right to left, count 14 empty sockets in the edge of the mat. Mount numbers 14 and 15 onto the rods either side of the next frame joint. (This leaves 13 unconnected rods between groups)

Tip: Push the rod in with your right hand, palm facing up, and with your elbow to hip, while pulling the mat socket left and up with the left hand. This method uses your body weight to flex the rods (rather than pure arm strength), and it also keeps your face away from the loaded rods (Figure 13-B).

Tip: It is easiest to mount the rod ball to the fitting by pushing the rod in and up towards the mat, while pulling the mat fitting to the left. The ball then pushes back naturally into the fitting (some rods will need to be bent a long way at first).

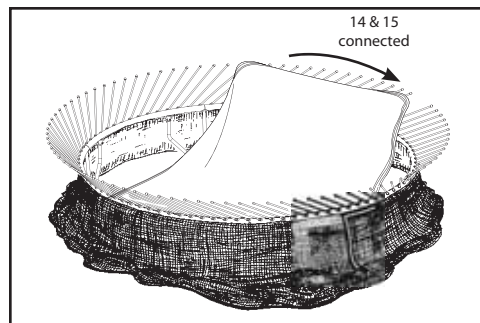

Figure 13-A: Attaching the next (14th and 15th) rods

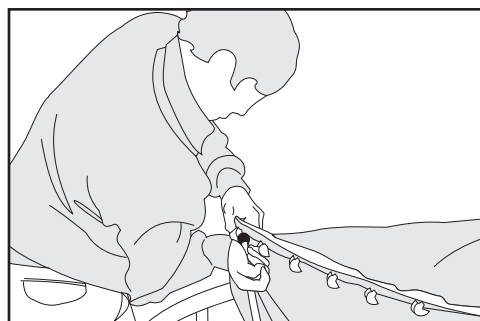

Figure 13-B: Preferred rod bending technique

WARNING: Treat any loaded rod with caution until you are sure it is properly installed or uninstalled. Keep your face well away from any loaded rod.

Step 14: Attaching every 14th and 15th rod to the mat

Continue around the tramp from right to left, mounting every fourteenth and fifteenth mat socket on to the rods on either side of each frame joint.

Ensure that each ball is properly resting in the mat socket and that the safety clip has closed behind the ball (See Step 12).

Tip: If you miscount, and need to release a connected rod, release the clip before trying to disconnect the ball from the mat socket. The clip is released by pushing the lever towards the mat centre. Apply pressure on the rod until it is unloaded (Figure 14-B).

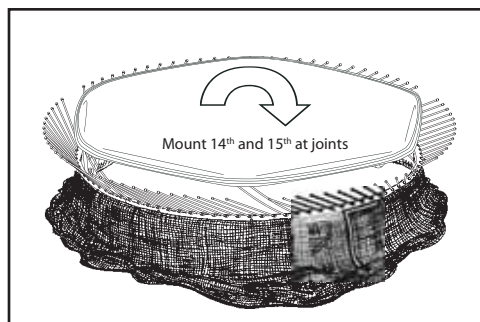

Figure 14-A: Every 14th and 15th rod attached

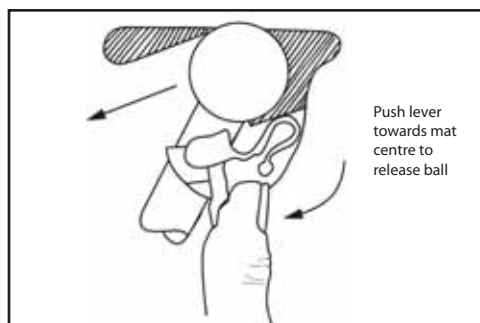

Figure 14-B: The release clip on the mat fitting

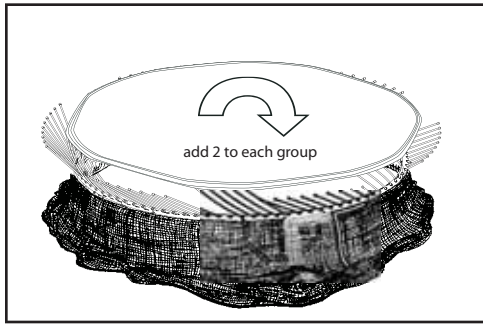

Figure 15-A: Adding 2 rods per group

Step 15: Attaching the remaining rods to the mat

Now install two more rods to the left of each group while circling the trampoline.

Continue to circle around the trampoline installing two rods per group until all rods are connected (Figure 15-B).

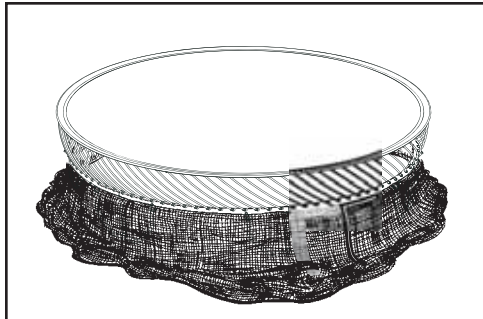

Figure 15-B: All rods attached to the mat

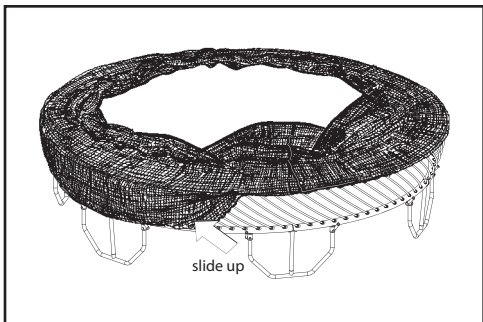

Figure 16: Sliding the net up the rods

Step 16: Sliding the enclosure net up the rods

Lift the enclosure net from the ground, up on to the trampoline mat. (It may be a tight fit over the mat edge.) Please ensure the net does not snag on the frame bolts as this may tear the net.

Circling the trampoline from right to left, slide the net bottom strip up the rods to the top, just under the mat edge. (The long zip will now end just left of the joint between the legs.)

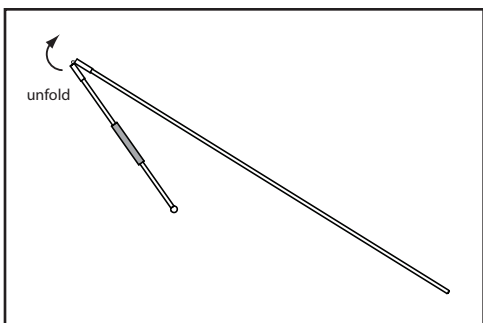

Figure 17-A: Straightening an enclosure rod

Step 17: Assembling the enclosure rods

Straighten the enclosure rods and slide the white joiner down to lock the two rods together (Figures 17-A, B and C).

WARNING: Treat any loaded rod with caution until you are sure it is properly installed or uninstalled. Keep your face well away from any loaded rod.

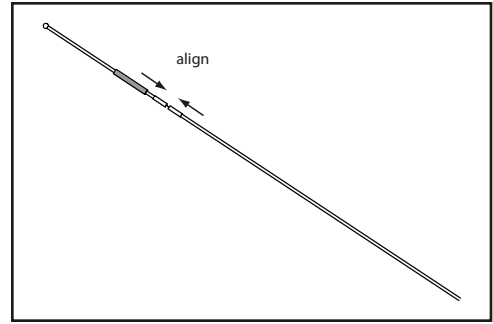

Figure 17-B: Aligning rod parts at the joint

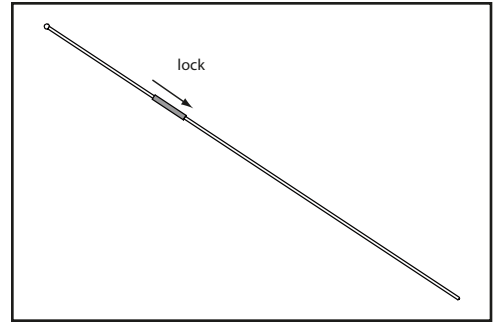

Figure 17-C: Locking the joint

WARNING: Never attempt to remove an enclosure rod from its socket or disengage (unlock) the joiner while the enclosure rod is under tension.

Step 18: Inserting the first enclosure rod

Insert the ball end of the rod up through the loop and into a pocket in the top edge of the net.

Ensure the rod is pushed right to the end of the pocket. Unless you do this, the internal catch cannot prevent the rod from coming out during use. Next, hoist the net up.

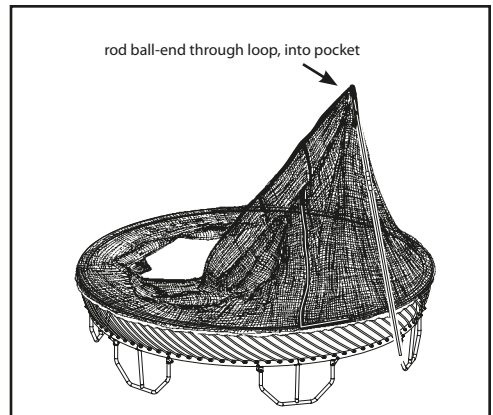

Figure 18: Inserting a rod into a pocket

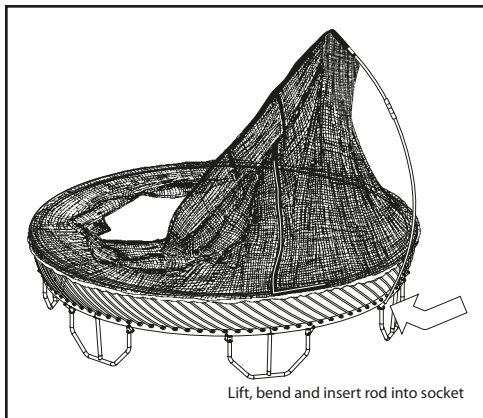

Figure 19: Inserting a rod into a socket

Step 19: Bending the enclosure rod into its socket

Bend the rod and insert the bottom end into the socket near the leg. Ensure that the rod is pushed right down into its socket locked into place by the C-clip. Next, do the rod opposite.

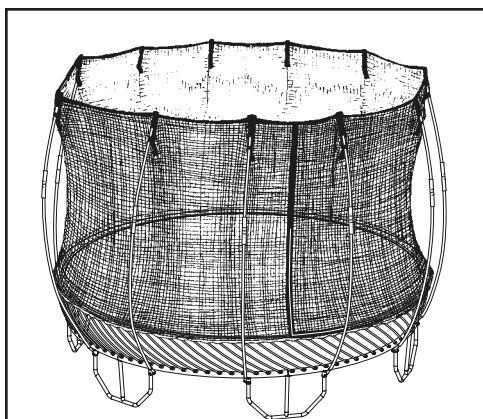

Figure 20: The completed trampoline with erected enclosure

Step 20: Completing the enclosure

Insert remaining enclosure support rods by the same process: put the top ball through the loop into the pocket, hoist the rod, then insert the bottom end of the rod into the socket by the leg.

Ensure the joiner-lock is engaged, holding the short and long pieces of the enclosure rod. Also, ensure that the rod is pushed right down into its socket and locked in place by the C-Clip.

Again, ensure rods are pushed right to the ends of the pockets so the internal catches will prevent them from coming out.

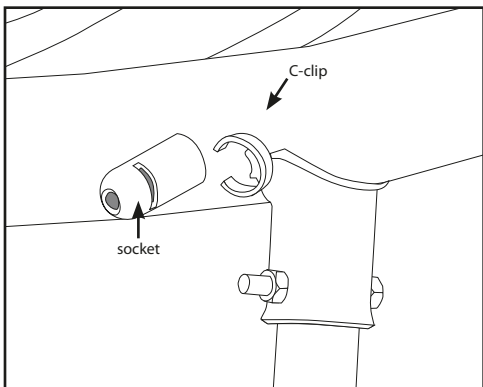

Figure 21: C-clip attaching to socket on frame

Step 21: Checking C-Clips are secure in sockets

C-clips should be pre-installed onto the sockets. Check and ensure the 12 C-clips are on the sockets. Ensure these clips capture the rods and prevent them from being pulled out.

Congratulations! You have successfully completed the assembly of your Springfree™ trampoline!

Be sure to review all warnings and precautions with your family before using. Happy jumping—the Springfree™ Trampoline way!

WARNING: The Springfree™ Trampoline has the industry's highest weight to area ratio. However, in extreme wind conditions the large surface area of the mat can capture enough wind energy to result in the trampoline being lifted from its installation location. Owners of trampolines installed in areas susceptible to high winds, or owners who wish to anchor their trampoline as a result of this warning should consider applying some type of anchoring system to the base of the trampoline legs.

Recommended Step: Use sandbags for increased stability

For increased stability, your trampoline comes with six sandbags, which you fill with sand and place over each leg (sand not included).

Fill the bag to approximately 6 inches (150 mm) below the top with wet or dry sand (Figure 22-A).

Fold the top of the bag twice over such that the Velcro strips meet (Figure 22-B).

Place one sandbag over each trampoline leg such that it cannot slip off (i.e. the stitched seam in the center should lay over the leg tube). (Figure 22-C).

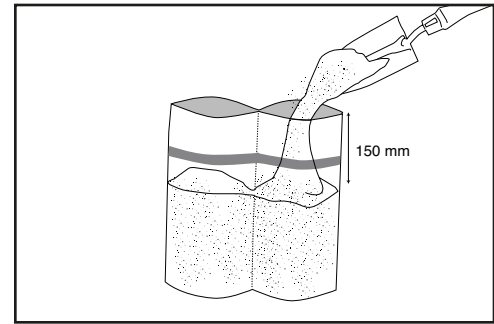

Figure 22-A: Filling the sandbag

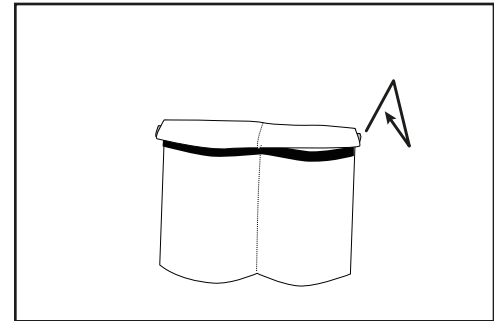

Figure 22-B: Folding and sealing the sandbag

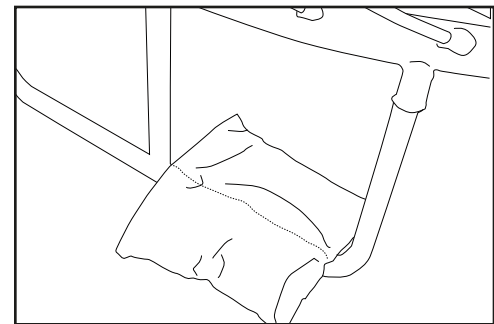

Figure 22-C: Placing the sandbag over the leg

TRAMPOLINE AND ENCLOSURE DISASSEMBLY INSTRUCTIONS

The disassembly is largely the reverse of the assembly steps. The following points should be noted:

Enclosure

First, remove the C-clips at the bottom of the enclosure rods, then lift the bottom of the enclosure rods out of their sockets in the frame. Once the net is slack, pull the rods from the pockets at the top of the net. The net will then be lying around the trampoline as in Step 13, Figure 13-A of the Trampoline and Enclosure Assembly Instructions.

WARNING: Never attempt to remove an enclosure rod from its pocket or disengage (unlock) the joiner while the enclosure rod is under tension.

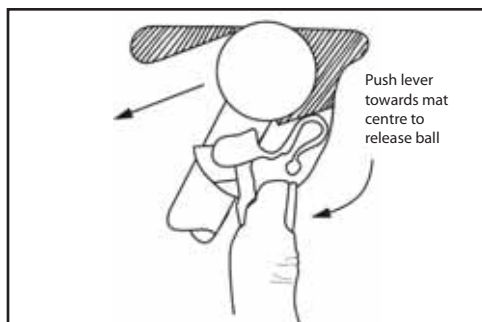

Figure 1: The release clip on the mat fitting

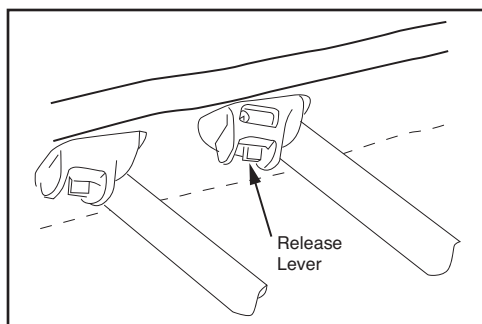

Figure 2: The release clip on the mat fitting (view beneath mat edge)

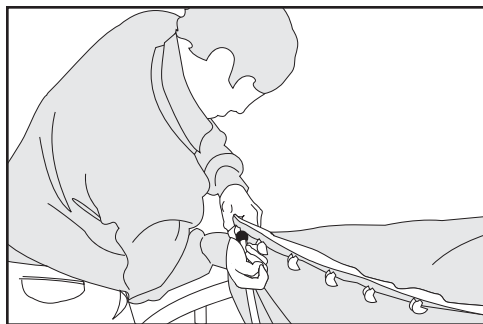

Figure 3: Preferred rod bending technique

TO FOLD THE ENCLOSURE ROD

1. Remove the enclosure rod assembly from the enclosure rod socket in the base of the trampoline.
2. Remove the rod assembly from the rod pocket at the top of the net.
3. Slide the white joiner up and fold the enclosure rods.

Trampoline

1. To release each rod, push the clip lever towards the mat centre, and hold (Figures 1 and 2). Then push the ball end of the rod towards the mat centre to disengage it from the socket (Figure 3).
2. Move around the trampoline releasing every fifth rod.
3. Continue circling, releasing rods to the right of the gap until all rods are released (by working at the right of the gap rather than the left, your knuckles have more clearance).
4. Once the mat is free, the frame can be disassembled.

Tip: One method to release a rod is to grip a pair of rods with the right hand while releasing the clip of the upper rod with the left hand. Now by tightening the grip on the two rods the upper rod ball slips out of the socket, while the rod is still held firmly in the hand. From there, the rod can be freed in a safe and controlled manner (Figure 3).

WARNING: Treat any loaded rod with caution. Keep your face well clear of any loaded rod.

WARNING: Do not attempt to disassemble any frame components before the mat and rods have been removed. The frame and legs need to remain assembled to carry the rod loads.

BASIC TRAMPOLINE SKILLS

These instructions contain information on basic skills, landing positions, and how to perform series of drops. The instructions are ordered according to difficulty. Further information is available from Springfree™ Trampoline or from a certified trampoline instructor. Basic jump-

ing and landing skills should be learned in a progression. More difficult skills should not be attempted until basic skills are mastered.



Figure 1: The Stop Bounce

Bouncing

The most important thing about bouncing is that it should be done with control in the centre of the bed. The basic bounce should always begin low. High, reckless bouncing should never be allowed.

THE STOP BOUNCE

This technique allows the jumper to gain control by stopping quickly. It is done by keeping the feet in contact with the bed, and absorbing the rebound of the trampoline with the knees and waist. This skill should be learned right away and should be employed whenever you feel out of balance, or land away from the centre area.

To learn the Stop Bounce:

1. Stand in centre of the bed with feet about hip-width apart.
2. Attempt about three easy bounces. Keep them low and controlled.
3. Focus your eyes towards the perimeter of the trampoline while bounding in order to keep your balance.
4. Stop the bounce by bending at your knees and hips with the feet in contact with the bed (see Figure 1).

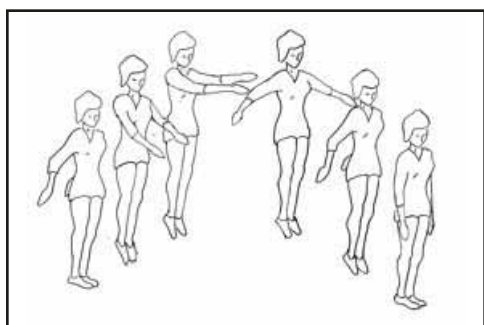

Figure 2: Arm Action

ARM ACTION

Arms are very important for proper control and lift. Whenever you go up, your arms go up. They go up to a set position about shoulder height and shoulder width. They should remain in this balanced position until you start down. Then they circle down and slightly behind the hips, ready to lift again as you bounce up.

BOUNCE VARIATIONS

The figures show four variations, the star, the tuck, the pike, and the straddle pike. These should be assumed at the top of the bounce, before resuming the normal landing position on your feet.

Practice these simple variations and concentrate on perfect form. Make sure that your toes are pointed and fingers are straight.

These are simple variations to the basic bounce and are very important for gaining experience in coordinated movement.



Figure 3: Tuck



Figure 4: Pike



Figure 5: Star



Figure 6: Straddle-pike

Basic Landing Positions

Positions for all drops: seat, hands and knees, front, should first be practiced on the ground, then in a stationary position, and only then on the trampoline bed.

Drops should be performed after 'priming' the trampoline bed. Priming is done by bending your knees and pushing down repeatedly on the trampoline bed, thereby setting the bed in motion. The feet stay in contact with the bed during the entire priming motion.



Figure 7: The seat drop

THE SEAT DROP

To learn the seat drop:

1. From the standing position, prime the bed several times.
2. Pick up your feet at the top of the last bounce, and sit down. You should land so that your body is in a sitting position with legs straight out in front and your toes pointed. Hands should be on the bed next to your hips. Fingers should be together and pointed toward the toes.
3. Push on the bed with your hands to rebound up to your feet.

THE HANDS AND KNEES DROP

To do this drop properly, there should be just as much weight on your hands as on your knees. Your back should be about approximately parallel to the bed. Knees and hands should land simultaneously, as with the middle of the body landing in the centre of the trampoline. Hands should be directly under the shoulders. Knees should be directly under the hips. Your toes should be pointed.

To learn the hands and knees drop:

1. Get down on your hands and knees on the bed. Make sure you have weight on both your hands and your knees. Do not sit on your heels.
2. Remain in this position and try to bounce. Do not rock back and forth between the hands and knees, but develop an even landing on all four points.
3. From the standing position, prime the bed several times. Lift upward with your hips, reach forward with your hands, and land on all fours. Look slightly in front of your hands on landing. Push to rebound to your feet.



Figure 8: The hands and knees drop

THE FRONT DROP

Contact with the trampoline bed should simultaneously take place with your hands, elbows, chest, stomach, hips, and knees. Knees should be bent.

You must come down level. If the landing is made first on your chest and arms, they will rebound before your knees hit which will result in a straining action on your back. If this type of landing is made with a traveling, diving approach there is a chance that your elbows may become skinned. If the landing is made so that your knees and hits hit first, then they will rebound and your shoulders and face will land heavily.

Step 1

1. Start from the hands and knees drop position.
2. As you rebound from the hands and knees, stretch so that you land on your stomach. From this position rebound to your hands and knees.

Step 2

1. Start from a standing position with knees bent so that your upper body is low and close to the trampoline bed.
2. Prime the bed several times.
3. Lift hips gently upward and backward.
4. Land in contact with the bed as described in Step 1.
5. Push with your hands to return to the feet.

Step 3

1. Start from a straight standing position.
2. Prime the bed several times.
3. Perform skill as in Step 2.



Figure 9: The front drop

Series of Drops

Once you have mastered the individual bounce variations and drops, practice them in sequence. For example: Set drop-Hands and knees drop-Front drop, or Seat drop-Front drop-Hands and knees drop-Seat drop.

Beginning Twisting

The figures show a few of the many possible twisting variations of the basic landing positions.

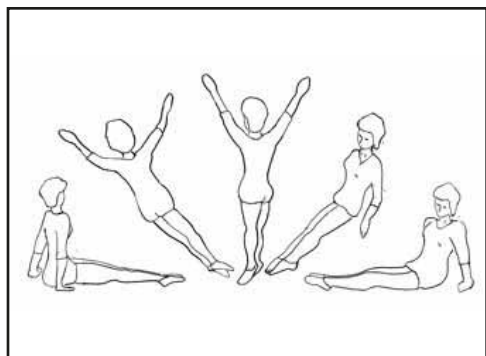

Figure 10: Swivel hips

SEAT DROP-HALF TWIST-SEAT DROP (SWIVEL HIPS)

Step 1

1. Perform a seat drop.
2. Push down on the bed with your hands and come to a stand with the arms stretched overhead.

Step 2

1. Perform the movement in Step 1. As you rebound up to your feet, move one shoulder in the direction you want to twist.
2. Finish standing with arms stretched overhead, facing the opposite direction (180-degree twist completed).

Step 3

Perform as in Step 2. Just before contacting feet with the trampoline bed, lift your legs to land in a sitting position.

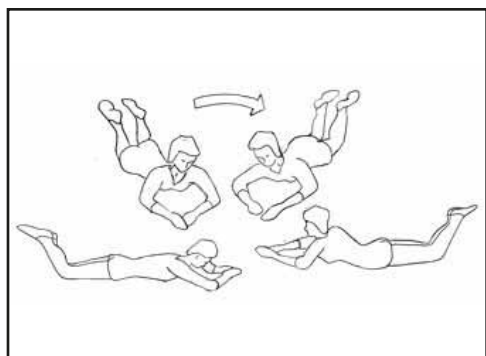

Figure 11: Turntable

FRONT DROP-HALF TWIST-FRONT DROP (TURNTABLE)

Step 1

1. Begin in a hands and knees position, with hands forming a triangle, like in a front drop.
2. Prime the bed in this position.
3. Push backward with your hands and extend your body to land in the front drop position.
4. Repeat several times in succession: Hands and knees drop-Front drop-Hands and knees drop-etc.

Step 2

Perform the movement as in Step 1. However, do it at twice the speed so as to bring your knees inward, under your hips and out again

without touching your knees on the bed.

Step 3

Perform the movement as in Step 2. Push sideways on the trampoline bed so that your body rotates like the hands of a clock.

Step 4

From a standing position, prime the bed, and then perform a front drop. Push sideways, as in Step 3, and complete a 180-degree turn, finishing in a front drop facing the opposite position.

SEAT DROP-FULL TWIST-SEAT DROP (FULL BARREL ROLL)

1. Perform this as you would a half-barrel roll but keep moving your shoulder in the direction of the twist so that you finish in the seat drop position.
2. During the twist, hands should be placed by your sides, with your body held straight.

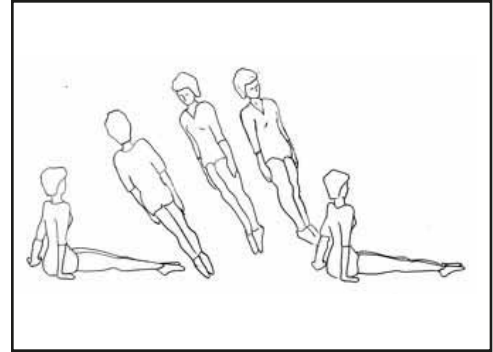

Figure 12: Full barrel roll

Additional Twisting

You can combine a twist with each of the basic landing positions. You can twist after the landing position.

Example: Seat drop – twist-feet

You can add more twists. Remember to practice and perfect the smaller twists before moving on to larger twists. You can also perform a series of twists.

Example: Swivel hips

Perform several in a row, all twisting in one direction, or alternating directions.

WARRANTY

Springfree™ Trampoline
Limited Trampoline Warranty

Warranty Coverage

Springfree™ Trampoline and its authorized service partners warrant its products to be free of defects in material and workmanship under normal domestic recreational use and service conditions. The various component parts of the trampoline are warranted against failure and defects in workmanship as follows:

Steel Frame	10 years
Jumping Mat	2 years
Fiberglass Rods	2 years
FlexiNet	1 year

The warranty in respect of the mat and the enclosure net does not cover normal wear & tear (e.g. stitching wear due to use), burns, cuts or snags. The warranty on the frame does not cover surface rust. Warranty claims resulting from manufacturing QA defects e.g. cuts in mat, broken cleats, tears in net, missing components etc must be reported within 45 days of the product being purchased. Warranty claims reported outside the initial 45 days purchase period may be rejected by Springfree™ Trampoline.

SPRINGFREE™ TRAMPOLINE IS NOT RESPONSIBLE OR LIABLE FOR INDIRECT, SPECIAL OR CONSEQUENTIAL DAMAGES ARISING OUT OF OR IN CONNECTION WITH THE USE OR PERFORMANCE OF THE PRODUCT OR ANY OTHER DAMAGES WITH RESPECT TO ANY ECONOMIC LOSS, LOSS OF PROPERTY, LOSS OF REVENUE OR PROFITS, LOSS OF ENJOYMENT OR USE, COST OF REMOVAL, INSTALLATION OR OTHER CONSEQUENTIAL DAMAGES. SOME STATES/TERRITORIES DO NOT ALLOW THE EXCLUSION OR LIMITATION OF INCIDENTAL OR CONSEQUENTIAL DAMAGES. ACCORDINGLY THE ABOVE LIMITATION MAY NOT APPLY TO YOU.

THE WARRANTY EXTENDED HEREUNDER IS IN LIEU OF ALL OTHER WARRANTIES AND ANY IMPLIED WARRANTY OF MERCHANTABILITY, OR FITNESS FOR A PARTICULAR PURPOSE IS LIMITED IN ITS SCOPE AND DURATION TO THE TERMS SET FORTH HEREIN. SOME STATES/TERRITORIES DO NOT ALLOW LIMITATIONS ON HOW LONG AN IMPLIED WARRANTY LASTS. ACCORDINGLY THE ABOVE LIMITATION MAY NOT APPLY TO YOU. THIS WARRANTY IS NOT TRANSFERABLE.

How to Return Product

All returns must be pre-authorized. To obtain authorization, fax or email the completed Warranty Authorization Form (WAF) at the back of the manual to your nearest Springfree™ Trampoline customer service centre or authorized service partner listed in the "Springfree™ Worldwide Authorized Service Contacts" section of this manual to obtain an authorization number. If you do not have a copy of the WAF form, contact Springfree™ who will provide you with the required authorization. Once the authorization is obtained, ship the product, freight prepaid to the designated service centre with proof of purchase and a description of the issue. Springfree™ Trampoline will replace or repair the product at Springfree™ Trampoline's option.

This warranty gives you specific rights. You may also have other rights, which vary, from one state or territory to another.

SPRINGFREE™ WORLDWIDE AUTHORIZED SERVICE CONTACTS

North America

Springfree Trampoline Inc.
7100 Warden Avenue, Unit 3
Markham, Ontario, Canada L3R 8B5

Email: sales@springfreetrampoline.com
Website: www.springfreetrampoline.com

Toll free: 1-866-899-7370

Fax: 1-905-948-0016

AUSTRALIA

Springfree Trampoline Aust Pty. Ltd.
60 Hoopers Road
Kunda Park
Queensland, 4556
Australia

free: 1800 JUMP SAFE

1800 123 204

fax: 07-5451 0170

email: fun@springfreetrampoline.com.au

web: www.springfreetrampoline.com.au

New Zealand

Supertramps Trampolines
37 Oxford Street, PO Box 1063
Levin, New Zealand

Email: enquiries@trampolines.co.nz

Website: www.trampolines.co.nz

Toll free: 0-800-501-115

Phone: 06-368-3960

Fax: 06-368-0134

If you require service on a Springfree™
Trampoline product and your territory is not
included in this list, then contact us via one of
our registered e-mail addresses above.

SPRINGFREE™ TRAMPOLINE WARRANTY AUTHORIZATION FORM

Please complete this form and forward it to Springfree Trampoline or your retailer when requesting product warranty assistance.

Contact details

Please enter your complete contact details to accelerate the warranty claim process.

First name*

Last name*

Apt.

Street and number*

City*

State*

Zip/Postal code*

Phone number*

Email address

Purchase details

In addition to the information below, **please attach a copy of your receipt, packing slip, or credit card statement.**

Place of purchase*

Date of purchase*

Warranty claim details

Please tick the component(s) for which the warranty claim is being made.

- | | | |
|--------------------------------------|--|--|
| <input type="checkbox"/> Steel frame | <input type="checkbox"/> Fibreglass rod | <input type="checkbox"/> Horizontal enclosure pole |
| <input type="checkbox"/> Leg member | <input type="checkbox"/> Enclosure net | |
| <input type="checkbox"/> Jumping mat | <input type="checkbox"/> Enclosure rod or joiner | |

Please describe briefly the component fault and what you think caused it:*

* Required field

† Springfree™ Trampoline Authorized Service Centers are listed in the rear of this manual.

