

R 79

springfree™
TRAMPOLINE

MEDIUM ROUND

Trampoline and Enclosure Assembly, Installation,
Care, Maintenance and Use Instructions

SPRINGFREE™ TRAMPOLINE
MODEL NO. R79

VERSION 1.2

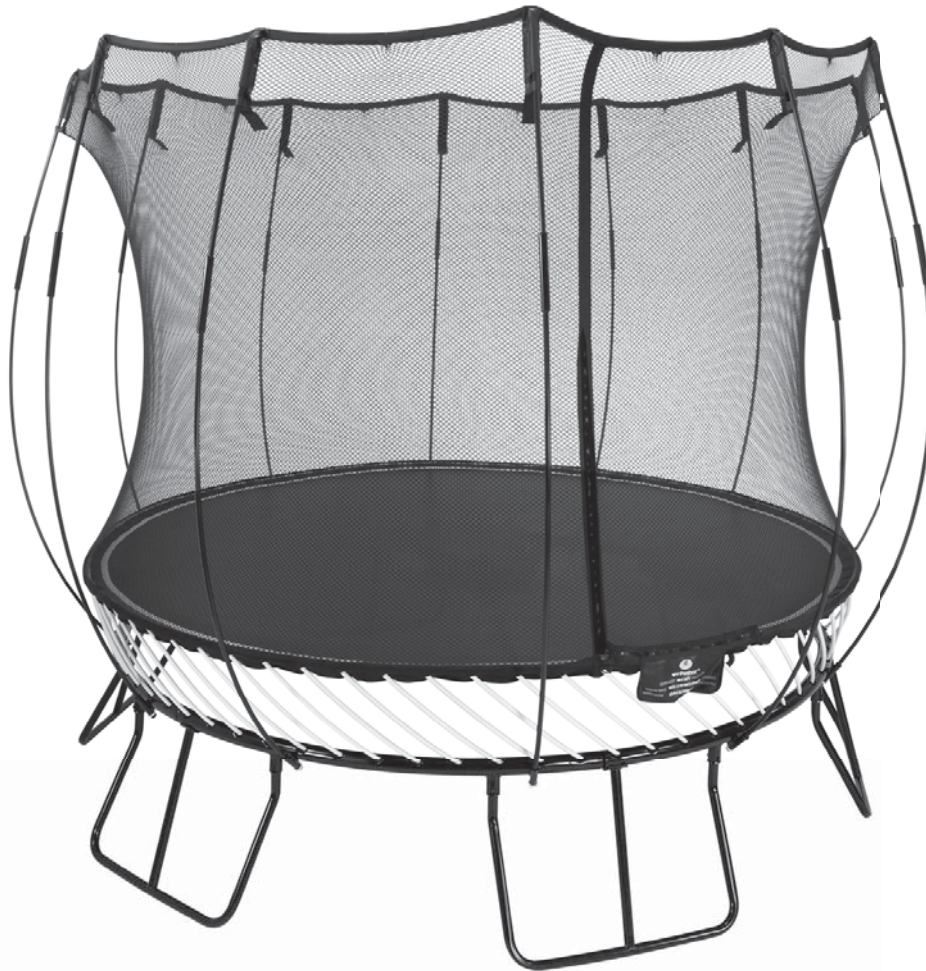

WARNING: Safety information, installation, and maintenance instructions - read these materials prior to assembling and using the trampoline and enclosure. In our commitment to customer satisfaction and safety, please check our website regularly for important customer updates.



WARNING: Read these materials prior to assembling and using this trampoline and enclosure



Do not attempt or allow somersaults. Landing on the head or neck can cause serious injury, paralysis or death even when landing on the middle of the bed.



Do not allow more than one person at the same time on the trampoline or enclosure. Use by more than one person can result in serious injury.

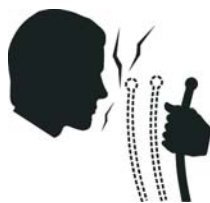

Keep face clear of loaded trampoline and enclosure rods, particularly during assembly and disassembly.

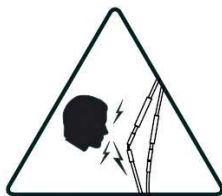

Do not attempt to disassemble trampoline enclosure rods from the rod joiner mechanism while the rods are installed in the trampoline and under tension.



Do not hold onto, or place fingers between the rods while someone is jumping on the trampoline.

Recommended Jumper Weight Rating: 220 lbs (100 kg)

The Springfree™ Model R79 trampoline has been designed for optimal use by most healthy children and adults. Persons at or near 220 lbs (100 kg) should be cautious in their maneuvers to ensure they do not initiate contact with the ground via the mat which may cause injury. The R79 has been static load tested to 1100 lbs (500 kg) using methodology described in standard BS EN 13219-2001.

Stability recommendation

The FlexiNet™ safety enclosure system catches and cushions users from impact that may result from leaving the jumping surface. Vigorous, high-speed contact with the FlexiNet™ safety enclosure by persons approaching the recommended weight limit may result in tilting or tipping of the trampoline off its base.

For increased stability during use, especially for users approaching the 220 lb (100 kg) weight limit, we recommend that you use the supplied sandbags (described in the assembly instructions). The sandbags also help keep the trampoline down in windy weather.

WARNINGS

1. Do not attempt or allow somersaults. Landing on the head or neck can cause serious injury, paralysis, or death, even when landing in the middle of the bed.
2. Do not allow more than one person on the trampoline/inside the enclosure. Multiple jumpers increase the chances of loss of control and this can result in broken head, neck, back, or leg, or other serious injury.
3. Use trampoline/enclosure only with mature, knowledgeable supervision. Enforce all safety rules and be familiar with the information in the User's Manual to assist in following trampoline enclosure instructions and trampoline safety.
4. Do not exceed the weight limit recommended by the manufacturer.
5. Trampolines over 20 in. (51 cm) tall, and enclosures, are not recommended for use by children under 6 years of age.
6. Inspect the trampoline/enclosure before each use. Make sure the barrier and the enclosure support system (rods) are correctly and securely positioned. Replace any worn, defective, or missing parts.
7. Climb on and off the trampoline at the enclosure door, it is a dangerous practice to jump from the trampoline to the floor or ground when dismounting, or to jump onto the trampoline when mounting. Do not use the trampoline as a springboard to other objects.
8. Do not jump from other objects, buildings, or surfaces, onto the trampoline, or into or over the trampoline enclosure.
9. Bounce in the center of the mat.
10. Stop bounce by flexing knees as feet come in contact with the trampoline bed. Learn this skill before attempting others.
11. Learn fundamental bounces and body positions thoroughly before trying skills that are more advanced. A variety of trampoline activities can be carried out by performing the basic fundamentals in various series and combinations, performing one fundamental after another, with or without foot bounces in between them.
12. Avoid bouncing too high or for too long. Stay low until bounce control and repeated landing in the center of the trampoline can be accomplished. Always control your bounce. Control is more important than height. Do not try to jump over the enclosure.
13. While keeping the head erect, focus eyes on the trampoline toward the perimeter. This will help control your bounce.
14. Avoid bouncing when tired. Keep turns short.
15. Bounce only when the surface of the bed is clean and dry. Wind or air movement should be calm to gentle. The trampoline must not be used in gusty or severe winds.
16. Do not allow a child or other persons under the trampoline.
17. Keep small children away from the trampoline while others are bouncing on it, because the edge can move in and out vigorously. There is potential for injury if the bouncer lands heavily on or near the edge.
18. Do not use the trampoline/enclosure while under the influence of alcohol or drugs.
19. Keep objects that could interfere with the jumper out of the way. Maintain a clear area around the trampoline.
20. Properly secure the trampoline/enclosure when not in use. Protect it against unauthorized use. If a trampoline ladder is used, the supervisor should remove it from the trampoline when leaving the area to prevent unsupervised access by children under 6 years of age.
21. Use only when the enclosure net has no holes, mat rods are secure in the mat edge sockets, the sockets are tightly secured to the trampoline frame, and the enclosure is properly suspended.
22. Do not intentionally rebound off the enclosure or intentionally jump into the enclosure. Do not hang, kick, cut or climb on the enclosure. Do not attempt to jump over or climb under the enclosure.
23. Wear clothing free of drawstrings, hooks, loops or anything that could get caught while using the trampoline/enclosure and result in entanglement and/or strangulation.
24. Do not attach anything to the enclosure that is not a manufacturer-approved accessory or part of the enclosure system.

25. This enclosure is to be used only in connection with certain trampolines. Read and follow all warnings and instructions before using the trampoline/enclosure. Warnings and instructions for the care, maintenance, and use of this trampoline are included to promote safe, enjoyable use of this equipment.
 26. For information concerning skill training, contact a certified trampoline instructor.
 27. The Springfree™ Trampoline has the industry's highest weight to area ratio. However, in extreme wind conditions the large surface area of the mat can capture enough wind energy to result in the trampoline being lifted from its installation location.
- Owners of trampolines installed in areas susceptible to high winds, or owners who wish to anchor their trampoline because of this warning should consider applying some type of anchoring system to the base of the trampoline legs.
28. In our commitment to customer satisfaction and safety, please check our website regularly for important customer updates and all trampoline specifications.
 29. For additional information concerning the trampoline equipment, please contact the manufacturer or regularly check our website for important customer updates. www.springfree.com for important customer updates.

The Springfree™ Trampoline and FlexiNet™ safety enclosure design is protected by a number of international patents (granted and pending) and registered designs. At the time of printing of this manual, these include: US patent 6319174; New Zealand patent 513331; China Patent ZL02825390.6; European registered design 000126602-0001; Australian registered design 311568-75; other international patents pending. Please check <http://www.uspto.gov> for latest updates. Springfree™ Trampoline is a registered trademark of Board & Batten International Inc. FlexiNet™ is a registered trademark of Board & Batten International Inc.

CONTENTS

7	Before you get started
9	Trampoline and Enclosure Assembly Instructions
19	Trampoline And Enclosure Disassembly Instructions
21	Basic Trampoline Skills
27	Warranty
28	Springfree™ Trampoline Worldwide Authorized Service Contacts
29	Springfree™ Trampoline Warranty Authorization Form

BEFORE YOU GET STARTED

Thank you very much for purchasing the Springfree™ Trampoline.

Before you assemble and enjoy the trampoline, please ensure that you read and fully understand the Warnings, Installation and Placement Instructions, Care and Maintenance Instructions, User and Owner Responsibilities and Assembly Instructions. In our commitment to customer satisfaction and safety, please check our website regularly for important customer updates and all trampoline specifications.

Trampoline and Safety Enclosure Installation and Placement Instructions

1. Adequate overhead clearance is essential. A minimum of 24 ft (7.32 m) from ground level is recommended. Provide clearance for wires, tree limbs, and other possible hazards.
2. Lateral clearance is essential. A minimum of 4 ft (1.22 m) clearance around the perimeter of the trampoline must be maintained at all times. Place the trampoline/enclosure away from walls, structures, fences, and other play areas. Maintain a clear space on all sides of the trampoline/enclosure.
3. Place the trampoline/safety enclosure on a level surface before use.
4. Use the trampoline/safety enclosure in a well-lit area. Artificial illumination may be required for indoor or shady areas.
5. Secure the trampoline/safety enclosure against unauthorized and unsupervised use.
6. Remove any obstructions from beneath the trampoline/safety enclosure.
7. Do not attempt to use the trampoline/safety enclosure until it is completely assembled.
8. The owner and supervisors of the trampoline/safety enclosure are responsible for ensuring all users are aware of practices specified in the use instructions.
9. The trampoline safety enclosure is only to be used as an enclosure for a trampoline and the trampoline must be of the appropriate size as covered by the specific enclosure.

Care and Maintenance Instructions

Inspect the trampoline/ safety enclosure before each use and replace any worn, defective, or missing parts. The following conditions could represent potential hazards:

1. Punctures, frays, tears, or holes in any part of the mat or net.
2. Deterioration in the stitching or fabric in any part of the mat or net.
3. Broken, missing, or splintered trampoline rods, or mat rods disconnected from the mat edge.
4. A sagging bed, or a loose enclosure net; improperly or insecurely attached bed or enclosure net.
5. Mat rods are not fully inserted into mat edge sockets or ball joints not fully engaged in mat edge.
6. Deteriorated, missing or damaged plastic mat edge sockets (If the mat edge sockets have deteriorated or are damaged, rods may release and cause injury. Inspect regularly, but keep face well clear in the process. Replace damaged components).
7. Enclosure rods and attachment fittings are missing, broken or improperly assembled.
8. Enclosure rods not fully up into the net pockets.
9. Missing C-clips from the sockets on the frame.
10. A bent or broken frame or sharp protrusions on the frame.

The soft edge of the Springfree™ Trampoline is designed to reduce injury. It is not designed to cope with deliberate, continuous, vigorous bouncing activity. Do not deliberately bounce around the edge.

Your Springfree™ Trampoline is manufactured using leading edge materials ranging from fiberglass to high tech polymer compounds. Over extended periods of outdoor exposure, and subject to the specific installation environment, the trampoline will accumulate dirt and surface build-up. Over prolonged periods, this can also include grime, moss, lichen, and insects.

1. Do not use any household or industrial cleaners (including oil or solvent-based cleaners) or hydrocarbon-propelled insecticides on your Springfree™ Trampoline. Applications of such products may result in degeneration of the product, and may void the consumer warranty.
2. The only cleaning product that should be used on your Springfree™ Trampoline is a mild liquid dishwashing soap. Ensure that it is labelled as dye and chemical free, non-toxic, and safe for use in hand washing.
Cleaning Your Springfree™ Trampoline:
 - Use a bucket of clean warm water.
 - Mix in 2 tsp (10 ml) of liquid dishwashing soap.
 - Gently work the water/soap mix into the area to be cleaned with a soft bristled scrub brush.
 - When finished, rinse the trampoline thoroughly with clean water.
3. If you have spider web build up on your trampoline, we recommend the use of a soft bristled broom and/or a cleaning product as described above.

Winter Care Instructions

Customers who live in colder climates frequently ask us how to care for their trampoline in the winter. Springfree™ trampolines are constructed with all-weather parts including rust-free fiberglass rods and UV-resistant polypropylene mat and safety enclosure. However, there are several steps you can take to protect your trampoline from winter climate extremes and these special winter care instructions will prolong the life and improve the performance of your Springfree investment.

1. In areas where snow falls and accumulates over the winter months, regularly clear the snow off your trampoline. ***Note: Do not use a shovel to remove the snow from your trampoline, because it may damage the mat or enclosure net. The most effective tool is a soft bristle broom. Reach onto the center of the mat and pull the snow load towards you and off the edge of the mat.**
2. We recommend the installation of our All Weather Cover, where the trampoline is likely to be left unused over the course of the winter. This is easily installed and will protect both your FlexiNet™ Enclosure Net and mat from the worst of winter weather and is designed to make snow removal easier.

Responsibilities for Trampoline Safety and Accident Prevention

RESPONSIBILITIES OF THE OWNER AND SUPERVISOR

1. Use trampoline/enclosure only with mature knowledgeable supervision.
2. Provide supervision for all jumpers regardless of age or skill.
3. Understand all of the safety rules and information in the User's Manual and ensure the rules are being followed.
4. Assess skill levels, provide basic jump instructions, and ensure all users understand and follow the trampoline safety guidelines.
5. Ensure that unsupervised or unauthorized users are not permitted to jump.
6. Keep small children away from the trampoline while others are bouncing on it.
7. Do not allow a child or other persons under the trampoline.
8. Do not allow more than one person on the trampoline/ in the enclosure at a time.
9. Inspect the trampoline/enclosure before each use to avoid potential hazards.

RESPONSIBILITIES OF THE USER

1. Climb on and off the trampoline. Do not jump on or off the trampoline.
2. Before jumping warm up the muscles. This increases blood flow, which increases flexibility, joint mobility and reduces the risk of injury.
3. When initially using the trampoline, begin in the center of the mat with low controlled bounces.
4. Understand basic techniques such as stop bounce and basic straight jump. Refer to Basic Trampoline Skills section at the end of this manual.
5. Understand and follow all the safety guidelines. In particular, do not attempt or allow somersaults and do not allow more than one person on the trampoline/ in the enclosure at a time.
6. Make sure someone is supervising at all times.

For further information or additional instructional materials, contact a certified trampoline instructor.

SPRINGFREE™ TRAMPOLINE AND ENCLOSURE ASSEMBLY INSTRUCTIONS

Read the following steps before beginning the assembly process.

Precautions

- Keep small children at least 25 ft (7.62 m) away while assembling or disassembling the trampoline; they could be injured by improperly assembled rods releasing and ejecting from the frame.
- Do not attempt to use the trampoline until it is completely assembled.
- Two people are recommended for trampoline assembly.
- Gloves are recommended during the assembly process.
- Be aware that when loaded, the rods can spring back and may cause injury.
- Treat any loaded rod with caution until you are sure it is properly installed. In particular, keep your face well clear of the rods during assembly or disassembly. An improperly installed rod could release and cause facial injury or blindness.
- The sleeves on the rods are intended to provide protection from any fiberglass fibers or splinters. Do not remove the sleeve.

TRAMPOLINE		ENCLOSURE	
Frame Sections	6	FlexiNet™ Safety Enclosure	1
Legs	6	Enclosure Rods	12
Center Posts	6	C-clips (attached to frame)	12
Mat Rods	72		
Mat	1	SPARES	
Bolts & Nuts	12	Spare Bolt/Nut	1
Wrench & Hex Key	2	C-clips	3
Sandbags	6		

Table 1: Parts Itinerary

Preparation

Confirm all components are present (Table 1). If you are missing any parts please call your authorized Springfree dealer.

Note: Bolts & Nuts

Small Bolts

Standard - 5/16" X 2"

Metric - M8 X 50 mm

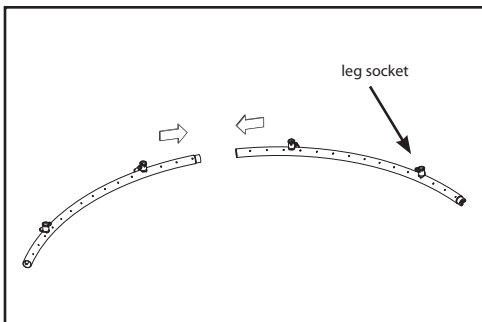

Figure 1: Assembling frame sections

Step 1: Assembling the frame sections

Assemble one pair of frame sections, with the leg sockets facing upwards.

Step 2: Attaching legs to frame sections

Locate the joint between two connected frame sections.

Insert a center post into a leg piece (Figure 2-A). Next, insert the leg with the center post into the sockets on the frame.

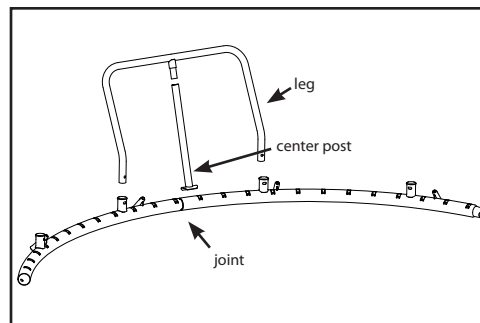

Figure 2-A: Inserting a leg piece and center post

Step 3: Fastening the legs to the frame

Fasten the legs to the frame with the bolts and nuts provided. Do not over-tighten.

If the holes do not line up, check that the leg has been inserted properly (refer to Figure 2-B) or lift the leg slightly.

The nut should be towards the mat center; the bolt head should be towards the outside.

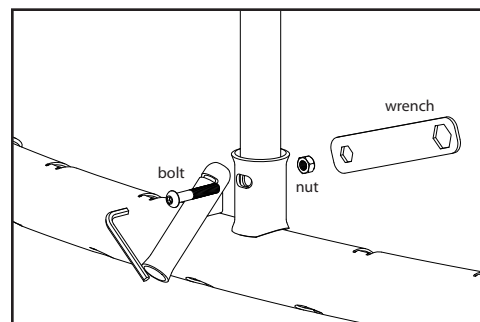

Figure 3: Fastening the legs to the frame

*NOTE: Use the tools provided or manual tools such as a socket wrench to fasten the bolts on the trampoline frames or legs. Do not use a power driver, torque wrench, or drill as these may over tighten the bolts. Only do the bolts up snugly, there is no need to do them up really tight. If you are having trouble inserting the main frame bolts, try to move the frame to a slightly flatter location, as assembling the trampoline on unlevel ground can make this difficult.

Step 4: Connecting frame pairs

Repeat Step 1 through Step 3 for the remaining frame sections.

Turn the three groups over, and then connect them together to complete the frame.

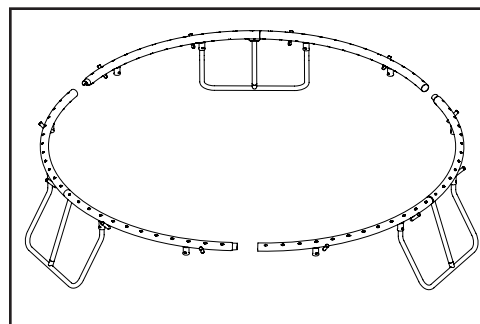

Figure 4: Connecting the frame sections

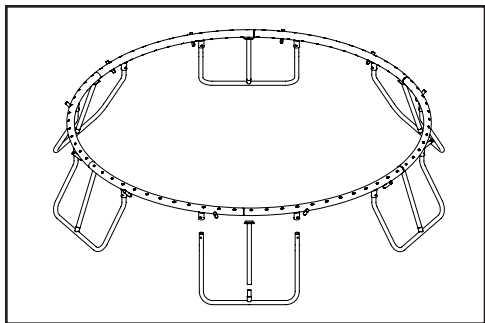

Figure 5: Attaching the final legs and center posts

Step 5: Attaching the final legs

Install a leg unit with a center post into each of the three remaining socket pairs.

As before make sure the saddle of each center post meets at the joint in the frame. If not, remove the leg and turn it around.

✳ When assembling the curved frame sections and legs, you will likely notice that the frame looks somewhat loose and the areas where the curved frame sections meet may appear to buckle. Do not worry - this is completely normal and occurs because the frame is not yet under tension. As you continue installation, and particularly as you begin installing the mat rods and the mat, the frame will become tight and rigid. By the time your trampoline is fully installed, the frame sections should fit tightly together.

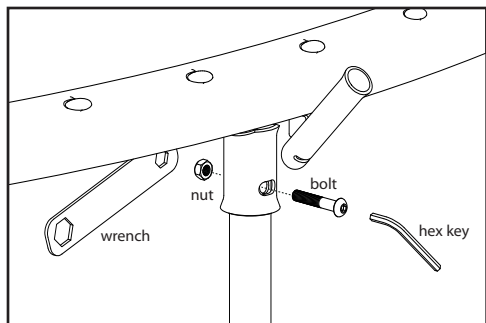

Figure 6: Fastening the last three legs

Step 6: Fastening the final legs

Fasten the remaining legs to the frame with the bolts and nuts provided. Do not over-tighten. Check that there is a bolt properly installed in each of the twelve leg uprights.

Again, the nut should be towards the mat center; the bolt head should be towards the outside.

It is essential for the stability of the frame that there is a bolt in each leg upright.

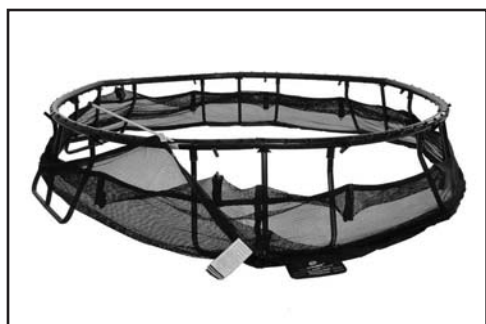

Figure 7: The net laid around the frame

Step 7: Positioning the enclosure

✳ NOTE: When you get to Step 7 and 8, you need to be extra careful that you don't install the net inside out. When placing the net around the frame, it is helpful to imagine how it will look once it is fully assembled – the text on the tab under the door and the pockets at the top of the net should be facing out once the net is up. If you lay the net around the frame with this perspective in mind, it will be much easier. Then, after inserting the first couple of rods through the net into the frame, it is a good idea to try lifting the top band of the net (the thin strip around the top of the net where the pockets are) up high enough to ensure you have it right. Ensure you have the enclosure net door located in the correct position and the right way around, i.e. not inside out

Lay the enclosure net around the frame with the enclosure door (the zippers) between two legs on a straight frame section (Figure 7).

WARNING: Ensure rods are seated right down to the bottom of each socket. Rods that are improperly seated may eject unexpectedly, which may cause injury.

Step 8: Inserting the first rod

Find the strip at the lower part of the net with the holes in it. Select the hole that has a label "1st Rod Position" sewn next to it (Figure 8-A). Find the rod socket on the straight frame section that has the sticker "1st Rod Position" next to it (Figure 8-B).



Figure 8-A: Placing the first rod



Figure 8-B: The first rod through the net and in its socket

WARNING: Ensure the rods are seated right down to the bottom of each socket. Rods that are improperly seated may eject unexpectedly, which may cause injury.

Step 9: Inserting the remaining rods

Insert the remaining rods through each hole in the bottom strip of the enclosure and into the respective sockets.

Ensure the rods are seated right down to the bottom of each socket.

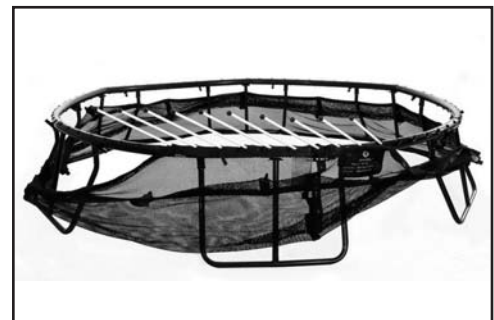

Figure 9: Inserting the remaining rods

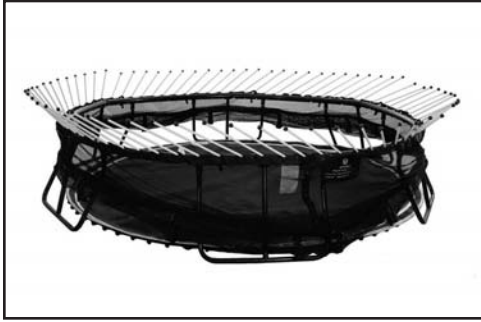

Figure 10: Placing the mat inside the frame

Step 10: Laying down the mat

When all rods are in place, put the mat inside the frame with the jumping surface facing up. The jumping surface has the colored (usually yellow) stripes sewn around the edge.

Go around the trampoline and make sure the net is not stuck under the leg or center posts before attaching the mat.



Figure 11-A: Attaching the mat to the rods

Step 11: Attaching the first rods to the mat

Choose the rod with the sticker "1st rod position." Connect the ball end of this rod to the mat edge socket in the mat marked with a label "1st rod position" (Figure 11-A).

WARNING: Treat any loaded rod with caution until you are sure it is properly installed or uninstalled. Keep your face well clear of any loaded rod.

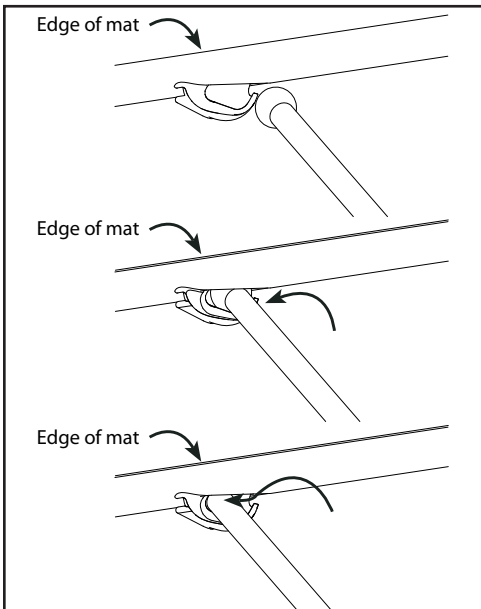

Figure 11-B: Fitting the mat rod into the mat edge socket

Tip: Make sure the ball is correctly seated in the mat-edge socket. If the ball is properly installed, you should not be able to slide the ball out of the mat edge socket (Figure 11-B).

Step 12: Attaching the next two rods to the mat

Working from right to left, count seven empty mat edge sockets in the edge of the mat. Mount the eighth and ninth rods; this leaves seven unconnected rods between the mounted rods.

* NOTE: Push the rod in with your right hand, palm facing up, and with your elbow to hip, while pulling the mat edge socket left and up with the left hand. This method uses your body weight to flex the rods (rather than pure arm strength), and it also keeps your face away from the loaded rods (Figure 12-B).

* NOTE: It is easiest to mount the rod ball to the mat edge socket by pushing the rod in and up towards the mat, while pulling the mat edge socket to the left. The ball then pushes back naturally into the mat edge socket (some rods will need to be flexed a long way at first).



Figure 12-A: Attaching the next (eighth and ninth) rods

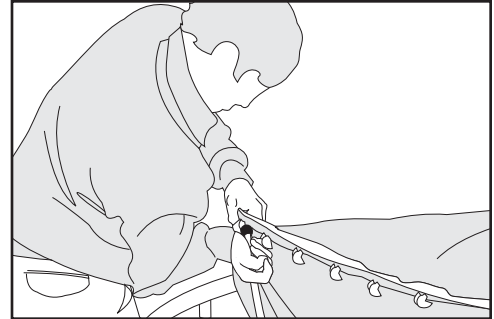

Figure 12-B: Preferred rod bending technique

WARNING: Treat any loaded rod with caution until you are sure it is properly installed or uninstalled. Keep your face well away from any loaded rod.

Step 13: Attaching every eighth and ninth rod to the mat

Continue around the tramp from right to left, mounting every eighth and ninth mat socket on to the rods on either side of each frame joint.

Ensure that each ball is properly resting in the mat socket (See Step 11).



Figure 13-A: Every eighth and ninth rod attached

* NOTE: If you miscount, and need to release a connected rod, hold the mat to the left of the rod with your left hand. Then using the technique outlined in Figure 12-B push the rod sharply at an angle towards the center of the mat and a little to your left. You should feel the rod move back in the mat edge socket then up and over a lip as shown in Figure 13-B.

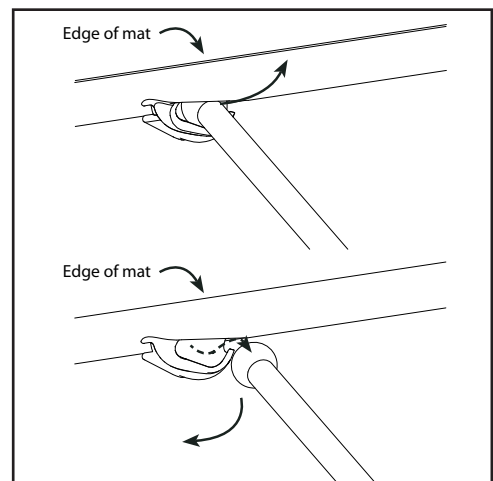

Figure 13-B: Removing the mat rod from the mat edge socket



Figure 14: Adding 2 rods per group

Step 14: Attaching the remaining rods to the mat

Now install two more rods to the left of each group while circling the trampoline.

Continue to circle around the trampoline installing two rods per group until all rods are connected.



Figure 15: Sliding the net up the rods

Step 15: Sliding the enclosure net up the rods

Lift the enclosure net from the ground, up on to the trampoline mat. (It may be a tight fit over the mat edge). Please ensure the net does not snag on the frame bolts as this may tear the net.

Circling the trampoline from right to left, slide the net bottom strip up the rods to the top, just under the mat edge. (The long zipper will now end just left of the joint between the legs).

To avoid unnecessary wear on the net, please ensure that the bottom net weave band covers the edge of the mat.

✱ **NOTE:** Be very careful that the net is not snagged on any of the bolts or enclosure rod sockets – if the net catches, it could result in a hole.

WARNING: Treat any loaded rod with caution until you are sure it is properly installed or uninstalled. Keep your face well away from any loaded rod.

Step 16: Assembling the enclosure rods

Straighten the enclosure rods and slide the white joiner down to secure the two rods together (Figures 16-A, B and C).

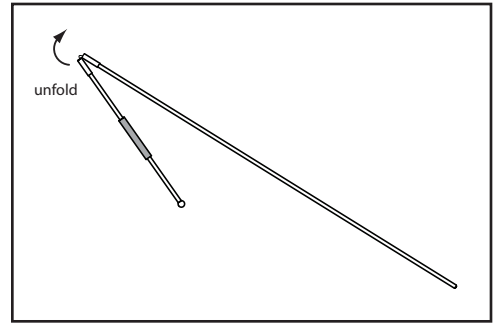

Figure 16-A: Straightening an enclosure rod

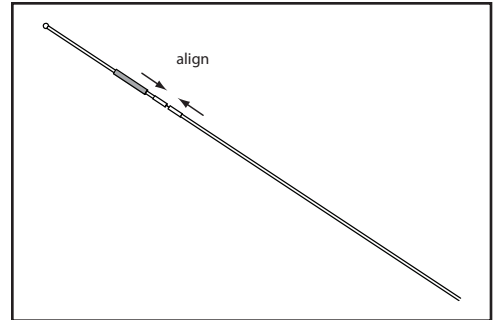

Figure 16-B: Aligning rod parts at the joint

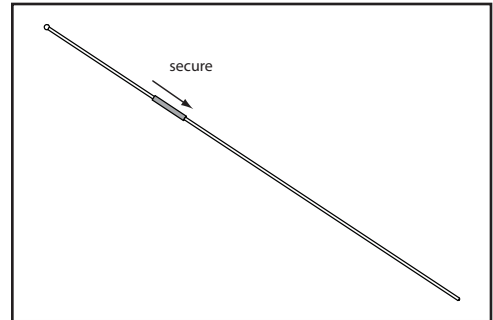

Figure 16-C: Securing the joint

WARNING: Never attempt to remove an enclosure rod from its pocket or disengage (unlock) the joiner while the enclosure rod is under tension.

Step 17: Inserting the first enclosure rod into the net pockets

Insert the ball end of the rod up through the loop and into a pocket in the top edge of the net.

* NOTE: Ensure the rod is pushed right to the end of the pocket. Unless you do this, the internal catch cannot prevent the rod from coming out during use (Figure 17).



Figure 17: Inserting an enclosure rod into a pocket

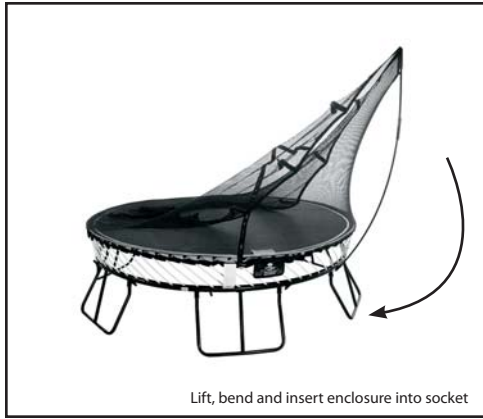

Figure 18: Inserting an enclosure rod into a socket

Step 18: Bending the enclosure rod into its socket

* NOTE: Insert ALL of the enclosure rods into the pockets BEFORE raising the enclosure net.

Next, hoist the net up. Bend the rod and insert the bottom end into the socket on the frame (Figure 18). Ensure that the rod is pushed right down into its socket and secured in place by the C-clip.

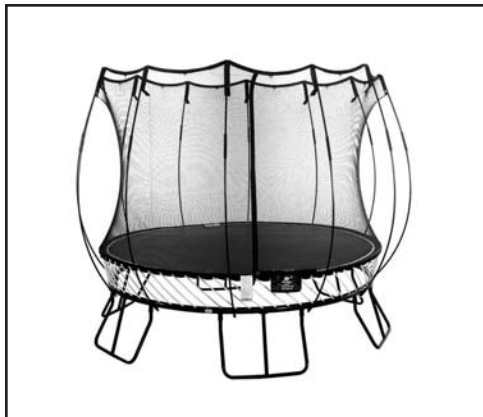

Figure 19: The completed trampoline with erected enclosure

Step 19: Completing the enclosure

Insert the next enclosure rod on the OPPOSITE side of the trampoline by the same process. Again, ensure that the joiner remains engaged. Continue installing the remaining enclosure rods using the same technique.

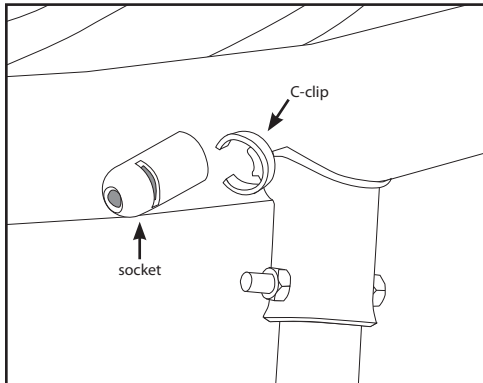

Figure 20: C-clip attached to socket on frame

Step 20: Checking C-Clips are secure in sockets

C-clips should be pre-installed onto the sockets. Check and ensure the 12 C-clips are on the sockets. Ensure these clips capture the rods and prevent them from being pulled out.

Congratulations! You have successfully completed the assembly of your Springfree™ Trampoline!

Be sure to review all warnings and precautions with your family before using. Happy jumping—the Springfree™ Trampoline way!

WARNING: The Springfree™ Trampoline has the industry's highest weight to area ratio. However, in extreme wind conditions the large surface area of the mat can capture enough wind energy to result in the trampoline being lifted from its installation location. Owners of trampolines installed in areas susceptible to high winds, or owners who wish to anchor their trampoline as a result of this warning should consider applying some type of anchoring system to the base of the trampoline legs.

Recommended Step: Use sandbags for increased stability

For increased stability, your trampoline comes with six sandbags, which you fill with sand and place over each leg (sand not included).

Fill the bag to approximately 6 in. (150 mm) below the top with wet or dry sand (Figure 21-A).

Fold the top of the bag twice over such that the Velcro strips meet (Figure 21-B).

Place one sandbag over each trampoline leg such that it cannot slip off (i.e. the stitched seam in the center should lay over the leg tube). (Figure 21-C).

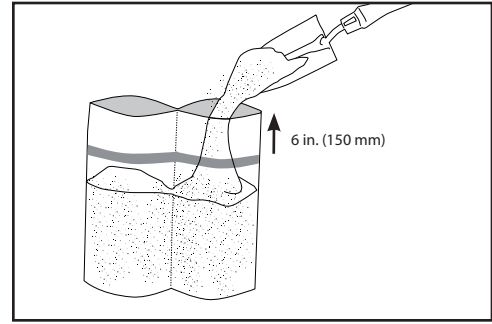

Figure 21-A: Filling the sandbag

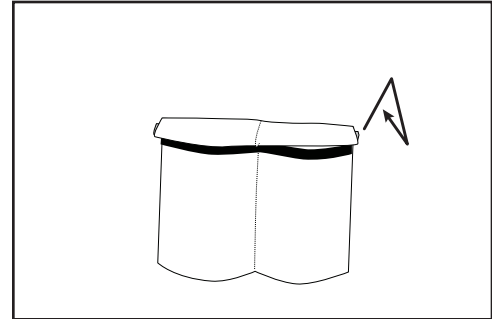

Figure 21-B: Folding and sealing the sandbag

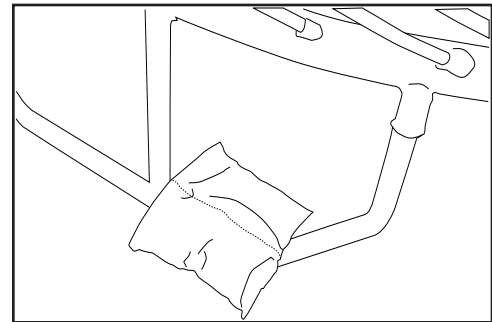

Figure 21-C: Placing the sandbag over the leg

TRAMPOLINE AND ENCLOSURE DISASSEMBLY INSTRUCTIONS

The disassembly is largely the reverse of the assembly steps. The following points should be noted:

Enclosure

First, remove the C-clips at the bottom of the enclosure rods and then lift the bottom of the enclosure rods out of their sockets in the frame. Once the net is slack, pull the rods from the pockets at the top of the net. The net will then be lying around the trampoline as in Step 14, Figure 14-B of the Trampoline and Enclosure Assembly Instructions.

WARNING: Never attempt to remove an enclosure rod from its pocket or disengage (unlock) the joiner while the enclosure rod is under tension.

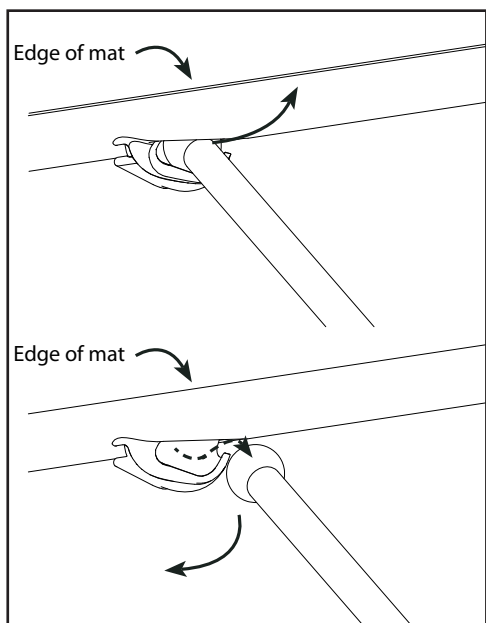

Figure 1: Removing the mat rod from the mat edge socket

TO FOLD THE ENCLOSURE ROD

1. Remove the enclosure rod from the enclosure rod socket in the base of the trampoline.
2. Remove the rod assembly from the rod pocket at the top of the net.
3. Slide the white joiner up and fold the enclosure rods.

Trampoline

1. Release each connected rod by hold the mat to the left of the rod with your left hand. Then using the technique outlined in Figure 1, push the rod sharply at an angle towards the centre of the mat and a little to your left. You should feel the rod move back in the socket then up and over the lip.
2. Move around the trampoline releasing every fifth rod.
3. Continue circling, releasing rods to the right of the gap until all rods are released (by working at the right of the gap rather than the left, your knuckles have more clearance).
4. Once the mat is free, the frame can be disassembled.

WARNING: Treat any loaded rod with caution. Keep your face well clear of any loaded rod.

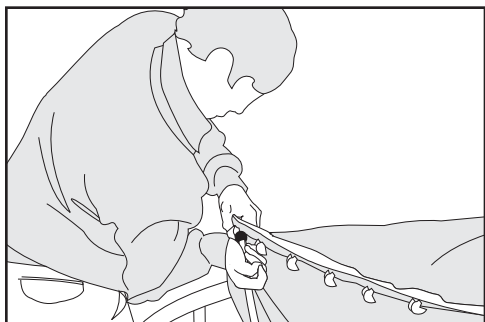

Figure 2: Preferred rod bending technique

WARNING: Do not attempt to disassemble any frame components before the mat and mat rods have been removed. The frame and legs need to remain assembled to carry the rod loads.

BASIC TRAMPOLINE SKILLS

These instructions contain information on basic skills, landing positions, and how to perform series of drops. The instructions are ordered according to difficulty. Further information is available from Springfree™ Trampoline or from a certified trampoline instructor. Basic jumping

and landing skills should be learned in a progression. Skills that are more difficult should not be attempted until basic skills are mastered.



Figure 1: The Stop Bounce

Bouncing

The most important thing about bouncing is that it should be done with control in the center of the bed. The basic bounce should always begin low. High, reckless bouncing should never be allowed.

THE STOP BOUNCE

This technique allows the jumper to gain control by stopping quickly. It is done by keeping the feet in contact with the bed, and absorbing the rebound of the trampoline with the knees and waist. This skill should be learned right away and should be employed whenever you feel out of balance, or land away from the center area.

To learn the Stop Bounce:

1. Stand in center of the bed with feet about hip-width apart.
2. Attempt about three easy bounces. Keep them low and controlled.
3. Focus your eyes towards the perimeter of the trampoline while bounding in order to keep your balance.
4. Stop the bounce by bending at your knees and hips with your feet in contact with the bed (see Figure 1).

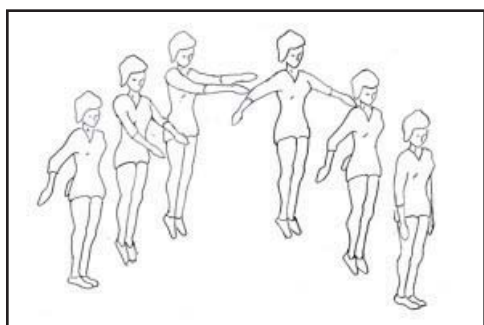

Figure 2: Arm Action

ARM ACTION

Arms are very important for proper control and lift. Whenever you go up, your arms go up. They go up to a set position about shoulder height and shoulder width. They should remain in this balanced position until you start down. Then they circle down and slightly behind the hips, ready to lift again as you bounce up.

BOUNCE VARIATIONS

The figures show four variations: the tuck, the pike, the star, and the straddle pike. These should be assumed at the top of the bounce, before resuming the normal landing position on your feet.

Practice these simple variations and concentrate on perfect form. Make sure that your toes are pointed and fingers are straight.

These are simple variations to the basic bounce and are very important for gaining experience in coordinated movement.



Figure 3: Tuck



Figure 4: Pike



Figure 5: Star



Figure 6: Straddle-pike

Basic Landing Positions

Positions for all drops: seat, hands and knees, and front drops should first be practiced on the ground, then in a stationary position, and only then on the trampoline bed.

Drops should be performed after 'priming' the trampoline bed. Priming is done by bending your knees and pushing down repeatedly on the trampoline bed, thereby setting the bed in motion. The feet stay in contact with the bed during the entire priming motion.



Figure 7: The seat drop

THE SEAT DROP

To learn the seat drop:

1. From the standing position, prime the bed several times.
2. Pick up your feet at the top of the last bounce, and sit down. You should land so that your body is in a sitting position with legs straight out in front and your toes pointed. Hands should be flat on the bed next to your hips. Fingers should be together and pointed toward the toes.
3. Push on the bed with your hands to rebound up to your feet.



Figure 8: The hands and knees drop

THE HANDS AND KNEES DROP

To do this drop properly, there should be just as much weight on your hands as on your knees. Your back should be about approximately parallel to the bed. Knees and hands should land simultaneously, as with the middle of the body landing in the center of the trampoline. Hands should be directly under the shoulders. Knees should be directly under the hips. Your toes should be pointed.

To learn the hands and knees drop:

1. Get down on your hands and knees on the bed. Make sure you have weight on both your hands and your knees. Do not sit on your heels.
2. Remain in this position and try to bounce. Do not rock back and forth between the hands and knees, but develop an even landing on all four points.
3. From the standing position, prime the bed several times. Lift upward with your hips, reach forward with your hands, and land on all fours. Look slightly in front of your hands on landing. Push to rebound to your feet.

THE FRONT DROP

Contact with the trampoline bed should simultaneously take place with your hands, elbows, chest, stomach, hips, and knees. Knees should be bent.

You must come down level. If the landing is made first on your chest and arms, they will rebound before your knees hit which will result in a straining action on your back. If this type of landing is made with a traveling, diving approach there is a chance that your elbows may become skinned. If the landing is made so that your knees and hips hit first, then they will rebound and your shoulders and face will land heavily.

Step 1

1. Start from the hands and knees drop position.
2. As you rebound from the hands and knees, stretch so that you land on your stomach. From this position, rebound to your hands and knees.

Step 2

1. Start from a standing position with knees bent so that your upper body is low and close to the trampoline bed.
2. Prime the bed several times.
3. Lift hips gently upward and backward.
4. Land in contact with the bed as described in Step 1.
5. Push with your hands to return to your feet.

Step 3

1. Start from a straight standing position.
2. Prime the bed several times.
3. Perform skill as in Step 2.



Figure 9: The front drop

Series of Drops

Once you have mastered the individual bounce variations and drops, practice them in sequence. For example, seat drop-Hands and knees drop-Front drop, or Seat drop-Front drop-Hands and knees drop-Seat drop.

Beginning Twisting

The figures show a few of the many possible twisting variations of the basic landing positions.

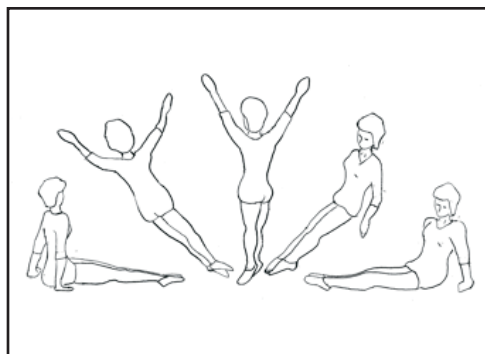

Figure 10: Swivel hips

SEAT DROP-HALF TWIST-SEAT DROP (SWIVEL HIPS)

Step 1

1. Perform a seat drop.
2. Push down on the bed with your hands and come to a stand with your arms stretched overhead.

Step 2

1. Perform the movement in Step 1. As you rebound up to your feet, move one shoulder in the direction you want to twist.
2. Finish standing with arms stretched overhead, facing the opposite direction (180-degree twist completed).

Step 3

Perform as in Step 2. Just before contacting feet with the trampoline bed, lift your legs to land in a sitting position.

FRONT DROP-HALF TWIST-FRONT DROP (TURNTABLE)

Step 1

1. Begin in a hands and knees position, with hands forming a triangle, like in a front drop.
2. Prime the bed in this position.
3. Push backward with your hands and extend your body to land in the front drop position.
4. Repeat several times in succession: Hands and knees drop-Front drop-Hands and knees drop-etc.

Step 2

Perform the movement as in Step 1. However, do it at twice the speed so as to bring your

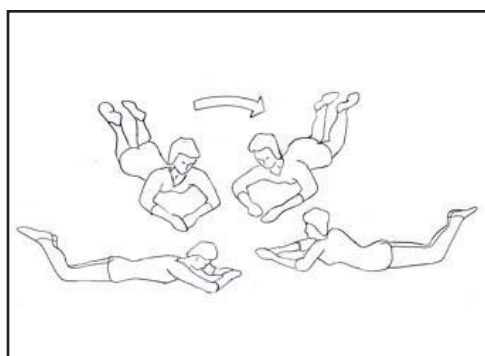

Figure 11: Turntable

knees inward, under your hips and out again without touching your knees on the bed.

Step 3

Perform the movement as in Step 2. Push sideways on the trampoline bed so that your body rotates like the hands of a clock.

Step 4

From a standing position, prime the bed, and then perform a front drop. Push sideways, as in Step 3, and complete a 180-degree turn, finishing in a front drop facing the opposite position.

SEAT DROP-FULL TWIST-SEAT DROP (FULL BARREL ROLL)

1. Perform this as you would a half-barrel roll but keep moving your shoulder in the direction of the twist so that you finish in the seat drop position.
2. During the twist, hands should be placed by your sides, with your body held straight.

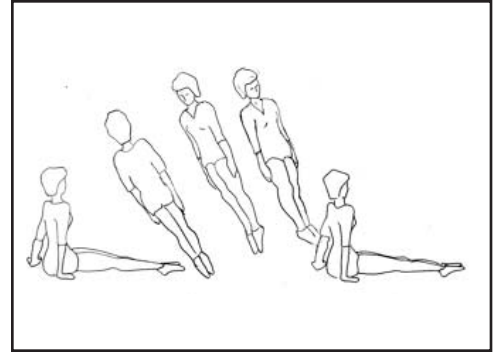

Figure 12: Full barrel roll

Additional Twisting

You can combine a twist with each of the basic landing positions. You can twist after the landing position.

Example: Seat drop – twist-feet

You can add more twists. Remember to practice and perfect the smaller twists before moving on to larger twists. You can also perform a series of twists.

Example: Swivel hips

Perform several in a row, all twisting in one direction, or alternating directions.

WARRANTY

Springfree™ Trampoline
Limited Trampoline Warranty

Warranty Coverage

Springfree™ Trampoline and its authorized service partners warrant its products to be free of defects in material and workmanship under normal domestic recreational use and service conditions. The various component parts of the trampoline are warranted against failure and defects in workmanship as follows:

Steel Frame	10 years
Jumping Mat	2 years
Fiberglass Rods	2 years
FlexiNet	1 year

The warranty in respect of the mat and the enclosure net does not cover normal wear & tear (e.g. stitching wear due to use), burns, cuts or snags. The warranty on the frame does not cover surface rust. Warranty claims resulting from manufacturing QA defects e.g. cuts in mat, broken cleats, tears in net, missing components etc must be reported within 45 days of the product being purchased. Warranty claims reported outside the initial 45 day purchase period may be rejected by Springfree™ Trampoline. Shipping costs associated with approved warranty claims during this 45 day period will be borne by Springfree™ Trampoline. Beyond this 45 day period, all shipping costs must be borne by the purchaser.

SPRINGFREE™ TRAMPOLINE IS NOT RESPONSIBLE OR LIABLE FOR INDIRECT, SPECIAL OR CONSEQUENTIAL DAMAGES ARISING OUT OF OR IN CONNECTION WITH THE USE OR PERFORMANCE OF THE PRODUCT OR ANY OTHER DAMAGES WITH RESPECT TO ANY ECONOMIC LOSS, LOSS OF PROPERTY, LOSS OF REVENUE OR PROFITS, LOSS OF ENJOYMENT OR USE, COST OF REMOVAL, INSTALLATION/DISASSEMBLY OR OTHER CONSEQUENTIAL DAMAGES. SOME STATES/TERRITORIES DO NOT ALLOW THE EXCLUSION OR LIMITATION OF INCIDENTAL OR CONSEQUENTIAL DAMAGES. ACCORDINGLY THE ABOVE LIMITATION MAY NOT APPLY TO YOU.

THE WARRANTY EXTENDED HEREUNDER IS IN LIEU OF ALL OTHER WARRANTIES AND ANY IMPLIED WARRANTY OF MERCHANTABILITY, OR FITNESS FOR A PARTICULAR PURPOSE IS LIMITED IN ITS SCOPE AND DURATION TO THE TERMS SET FORTH HEREIN. SOME STATES/TERRITORIES DO NOT ALLOW LIMITATIONS ON HOW LONG AN IMPLIED WARRANTY LASTS. ACCORDINGLY THE ABOVE LIMITATION MAY NOT APPLY TO YOU. THIS WARRANTY IS NOT TRANSFERABLE.

How to Return Product

All returns must be pre-authorized. To obtain authorization, fax or email the completed Warranty Authorization Form (WAF) at the back of the manual, including a proof of purchase and a minimum of two high resolution photos to your nearest Springfree™ Trampoline customer service centre or authorized service partner listed in the "Springfree™ Trampoline Worldwide Authorized Service Contacts" section of this manual to obtain an authorization number. If you do not have a copy of the WAF form, contact Springfree™ who will provide you with the required authorization. Once the authorization is obtained, ship the product, freight prepaid to the designated service centre and Springfree™ Trampoline reserves the right to replace or repair the product at Springfree™ Trampoline's option.

This warranty gives you specific rights. You may also have other rights, which vary, from one state or territory to another.

SPRINGFREE™ TRAMPOLINE WORLDWIDE AUTHORIZED SERVICE CONTACTS

NORTH AMERICA

Springfree Trampoline Inc.
151 Whitehall Drive, Unit 2
Markham, Ontario L3R 9T1
Canada

Toll free: 1 877 JUMP SAFE
Fax: 1-905-948-0016

Email: customerservice@springfree.com
Web: www.springfree.com

AUSTRALIA

Springfree Trampoline Aust Pty. Ltd.
Unit 1, 60 Hoopers Road
Kunda Park
Queensland, 4556
Australia

Free: 1800 JUMP SAFE
1800 123 204
Fax: +61-7-5453-9444

Email: fun@springfree.com.au
Web: www.springfree.com

NEW ZEALAND

Springfree New Zealand Ltd.
125 Blenheim Road, P.O. Box 80117
Riccarton, 8440
Christchurch, New Zealand

Free: 0800 JUMPSAFE
0800 586 772
Ph: +64-3-961-0529
Fax: +64-3-963-6999

Email: info@springfree.co.nz
Web: www.springfree.com

If you require service on a Springfree™
Trampoline product and your territory is not included in this
list, then contact us via one of our registered e-mail addresses
above.

SPRINGFREE™ TRAMPOLINE WARRANTY AUTHORIZATION FORM

Note: Proof of purchase and a minimum of two high resolution photos must be submitted with all warranty claims.

Please complete this form and forward it to Springfree™ Trampoline or your retailer when requesting product warranty assistance.

First name* _____ Last name* _____

Apt. _____ Street and Number* _____

City* _____ State/Province* _____ Zip/Postal Code* _____

Phone number* _____ Email address _____

Serial Number: _____ Model: _____
(Serial number is located on the trampoline frame)

Purchase details

In addition to the information below, **please attach a copy of your receipt, packing slip, or credit card statement.**

Place of purchase* _____ Date of purchase* _____

Please check the component(s) for which a warranty claim is being made:

- Frame Component Jumping Mat Enclosure Net Mat Rod Enclosure Rod/Joiner C-Clips Other

Please describe briefly the component fault and what you think caused it:*

- Photos of component enclosed/attached**

* Required field

† Springfree™ Trampoline Authorized Service Centers are listed in the rear of this manual.

